

Gateway to Extensions

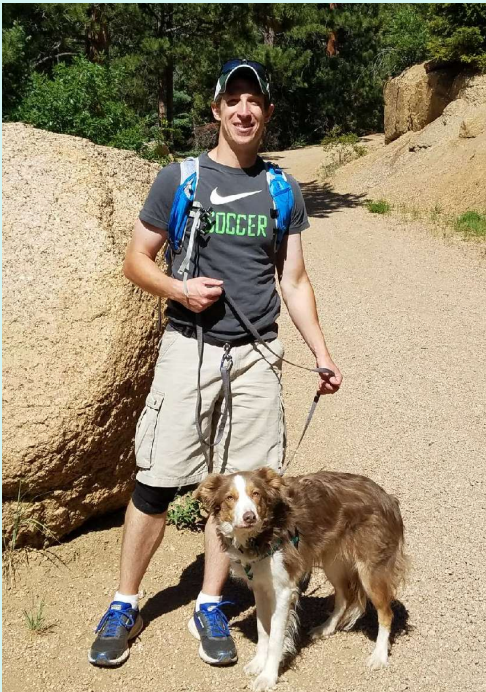

3DBASECAMP
2018
Palm Springs





Justin Geis

TheSketchUpEssentials.com

- [YouTube.com/TheSketchUpEssentials](https://www.youtube.com/TheSketchUpEssentials)

- The SketchUp Essentials YouTube Channel -

Almost 500 videos now about how to use SketchUp

Weekly SketchUp extension introduction and review videos



Resources from Today's Presentation

- www.TheSketchUpEssentials.com/Basecamp2018
- This presentation
- Links to tutorials on every extension I mention





My Goal -

Everyone in this room learns about at least one extension that's going to make their work significantly easier



Presentation Agenda

- What are Extensions?
- How to get them
- Overview of available extensions
- Extension Workshop



What are extensions and Why do you need them?



How long do you think this took to model?

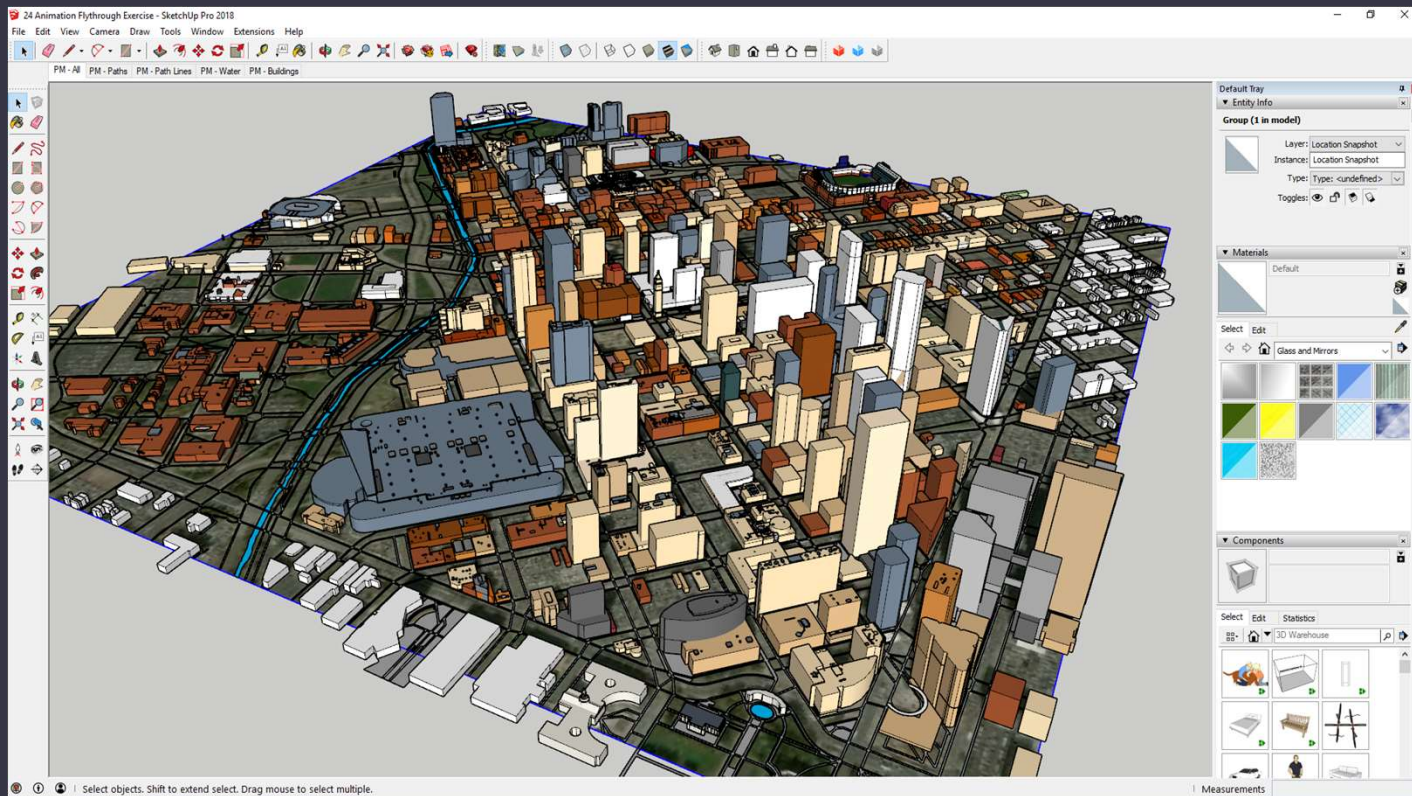

How would you make this in SketchUp?

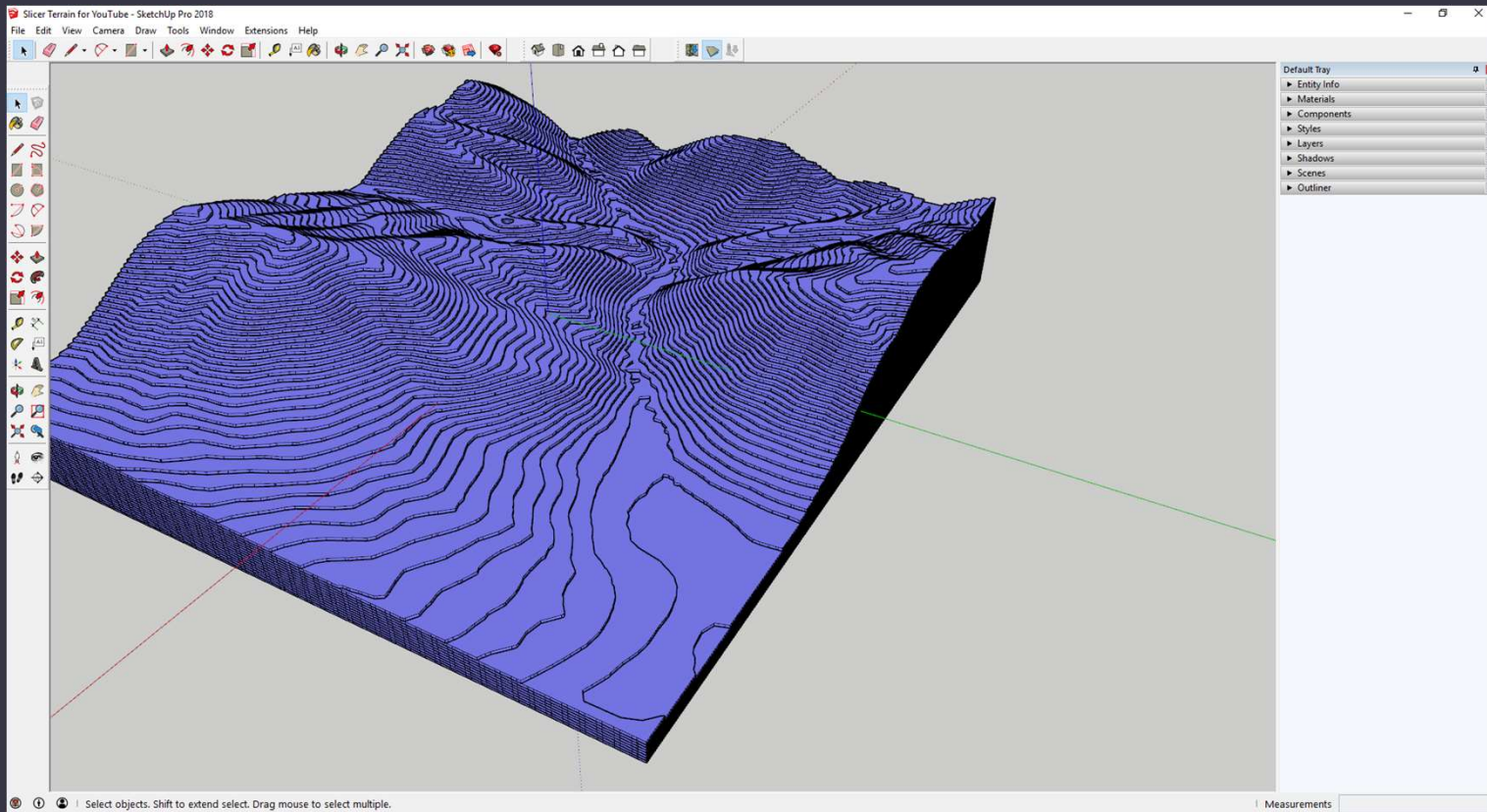

Did you think this was possible in SketchUp?





What are extensions?

- Extensions are basically scripts that you install in SketchUp to expand its functionality
- Written in a language called Ruby
- Only available in the desktop version of SketchUp



How many of you are using extensions right now in your workflow?







The goal should always be to make modeling in SketchUp faster and more efficient.

Extensions are how you get faster and more efficient



What kinds of extensions are available?

- General Tools
- Architecture
- Woodworking
- BIM
- 3D Rendering
- Location Modeling
- Interior Design
- Organic Modeling
- Construction
- Animation
- And more!

Where to get extensions

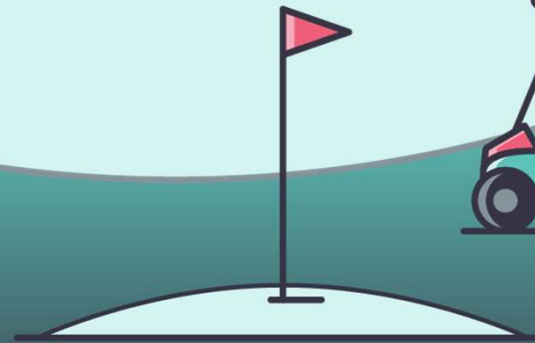
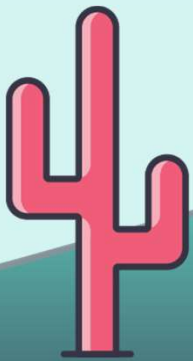

Where to Get Extensions #1

The SketchUp Extension Warehouse

- “Window”, “Extension Warehouse” within SketchUp
- Need to create a Trimble ID or you can use your Google Account
- Search for extensions by name, by category, or by developer

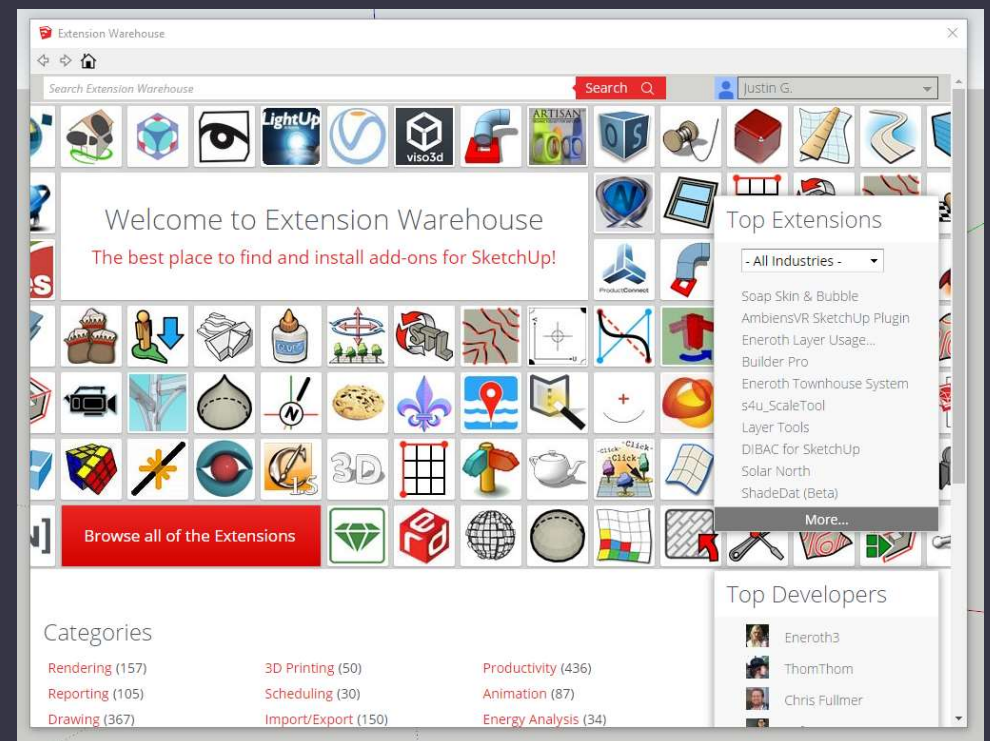

SketchUp Extension Information Page

- Name/Developer
- Reviews
- Instructions (Sometimes Video)
- SketchUp Compatibility – Very Important!
- Install/Update Button

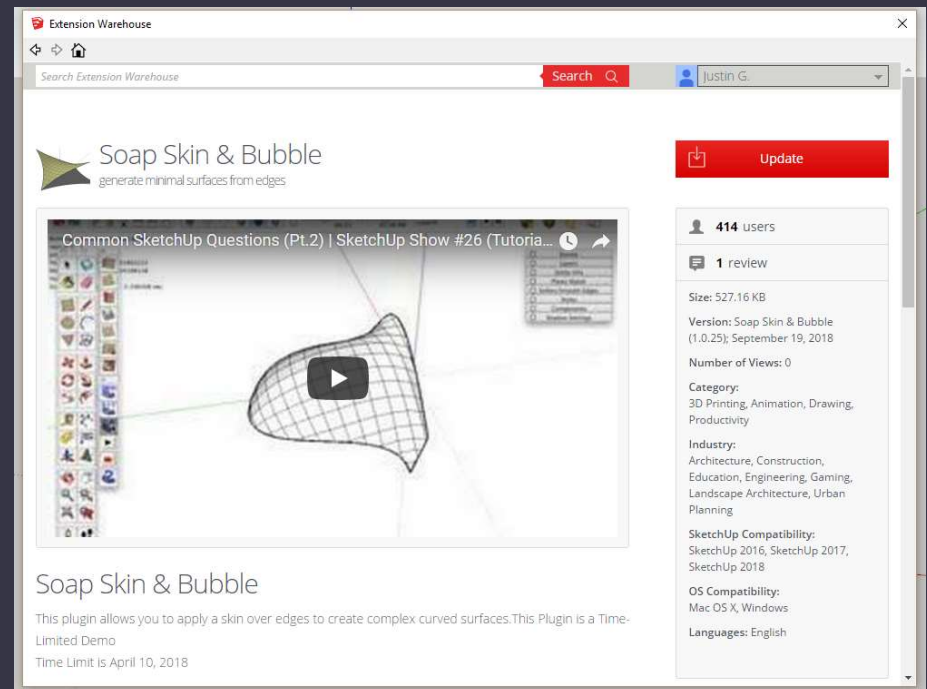

The screenshot shows the 'Soap Skin & Bubble' extension page on the SketchUp Extension Warehouse. The page features a search bar at the top with the text 'Search Extension Warehouse' and a search icon. The extension name 'Soap Skin & Bubble' is displayed with a green and yellow logo and the tagline 'generate minimal surfaces from edges'. A red 'Update' button is visible in the top right corner. Below the extension name is a video player showing a 3D model of a curved surface. The video title is 'Common SketchUp Questions (Pt.2) | SketchUp Show #26 (Tutoria...'. To the right of the video player is a sidebar with user statistics: '414 users' and '1 review'. Below the statistics, the page lists technical details: 'Size: 527,16 KB', 'Version: Soap Skin & Bubble (1.0.25); September 19, 2018', 'Number of Views: 0', 'Category: 3D Printing, Animation, Drawing, Productivity', 'Industry: Architecture, Construction, Education, Engineering, Gaming, Landscape Architecture, Urban Planning', 'SketchUp Compatibility: SketchUp 2016, SketchUp 2017, SketchUp 2018', 'OS Compatibility: Mac OS X, Windows', and 'Languages: English'. At the bottom of the page, there is a description: 'This plugin allows you to apply a skin over edges to create complex curved surfaces. This Plugin is a Time-Limited Demo. Time Limit is April 10, 2018'.

Where to Get Extensions #2

The SketchUcation Extension Warehouse

- www.SketchUcation.com
- Will need a Login
 - Use the Free Account Option!
- Similar search function to the SketchUp Extension Warehouse
- Available as a plugin to SketchUp as well

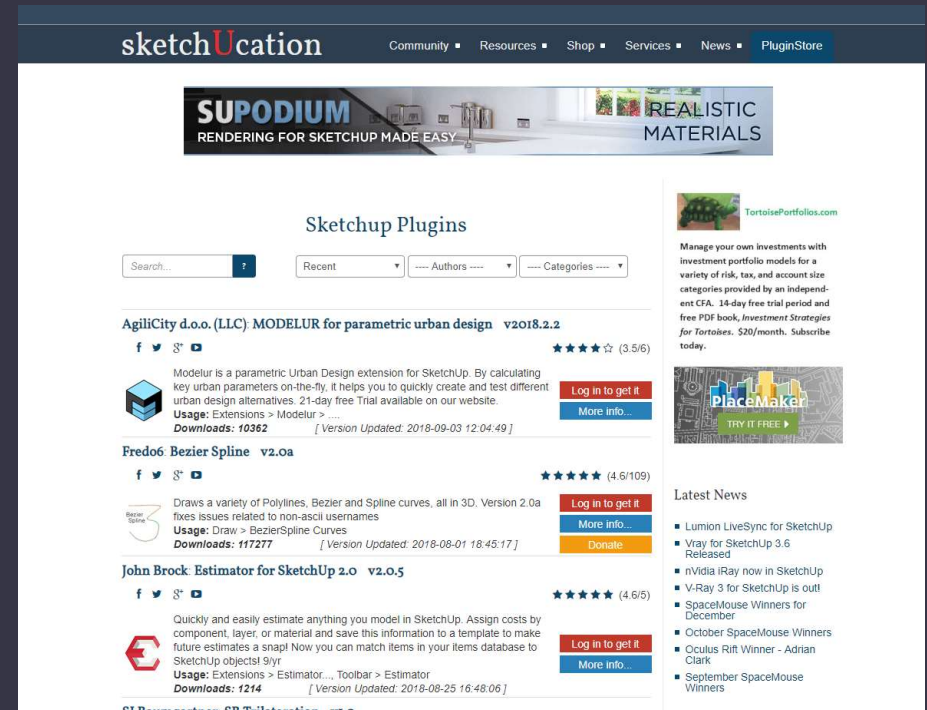

SketchUcation Extension Information Page

- Name/Developer
- Dependencies
- Install/Update Button
- **CLICK THE MORE INFO BUTTON!**



The screenshot shows the 'Sketchup Plugins' website interface. At the top, there is a search bar with a question mark icon, and three dropdown menus for 'Recent', 'Authors', and 'Categories'. Below this, the plugin 'Fredo6: Animator v2.2c' is featured. It includes social media icons for Facebook, Twitter, and YouTube, and a star rating of 4.2/43. A brief description states: 'Animator is a script dedicated to the animation of Sketchup models. It provides a parametric, interactive framework to control movements of objects and cameras along a timeline. Animator generates videos in various formats.' To the right of the description are three buttons: 'Log in to get it' (red), 'More info...' (blue), and 'Donate' (orange). Below the description, it lists 'Usage: Tools > Fredo6 Collection > Animator', 'Dependencies: LibFredo6 8.4a or higher', and 'Downloads: 28712' with a version update date of '2018-08-26 21:38:25'. At the bottom, there are tags for this article: 'sketchup plugins | sketchup extensions | plugin | plugins | sketchup | trimble | installing plugins | free sketchup plugins | free sketchup extensions | sketchup plugin tutorials | sketchup extension tutorials'.

SketchUcation Extension Store Download

- SketchUcation, Resources, Plugin Store Download
- Downloads a Ruby Script (Extension) file that you can install

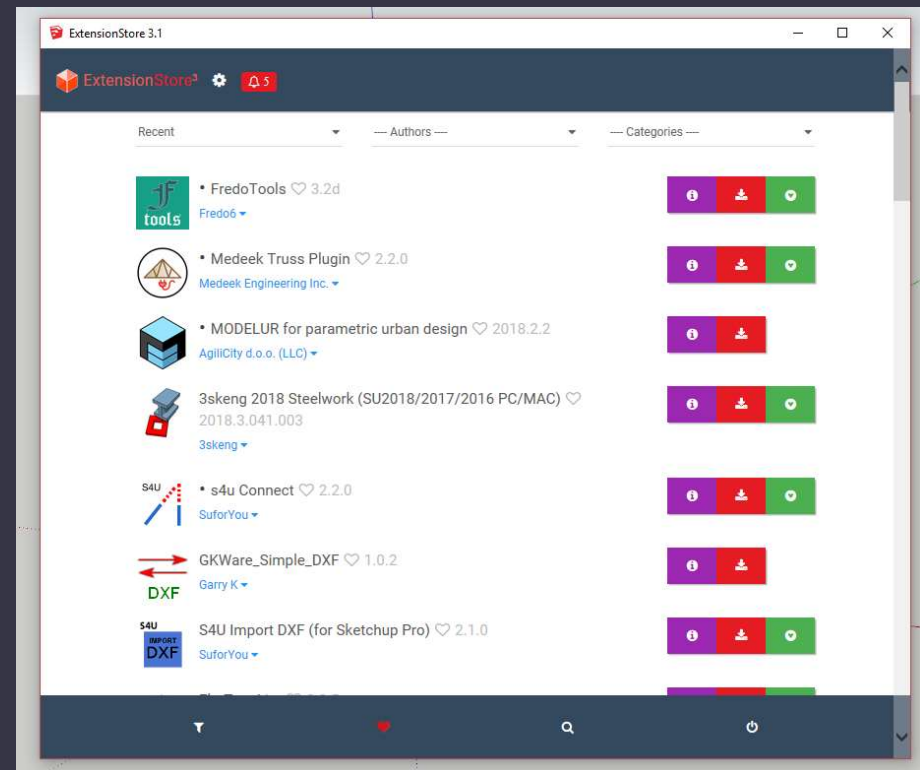

Where to Get Extensions #3

Product Websites

- Download Ruby Script Files Directly from Websites
- Install Using Extension Manager
 - Placemaker
 - FlexTools
 - Skatter
 - Many More

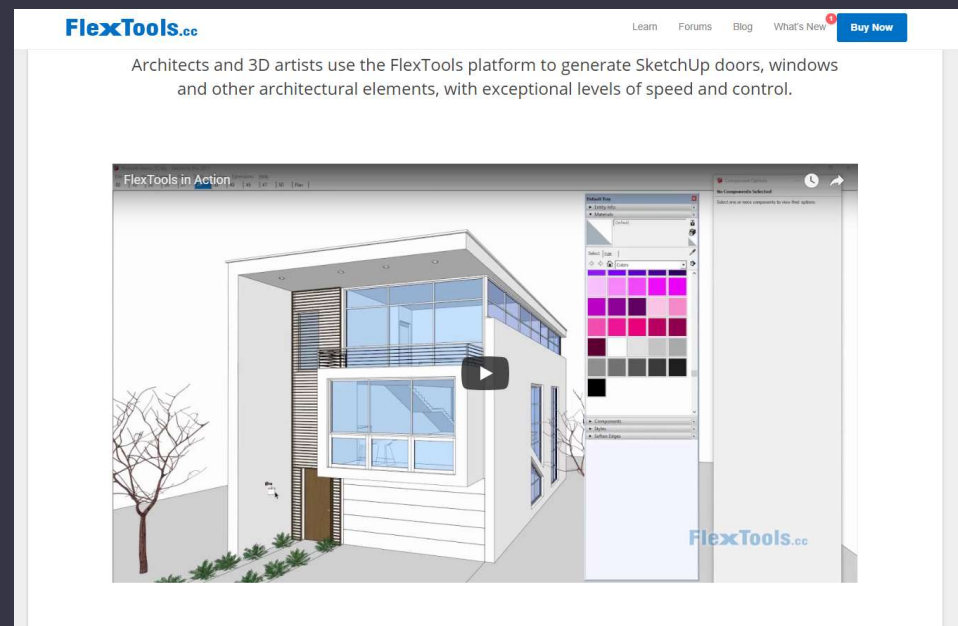

How to Install Extensions

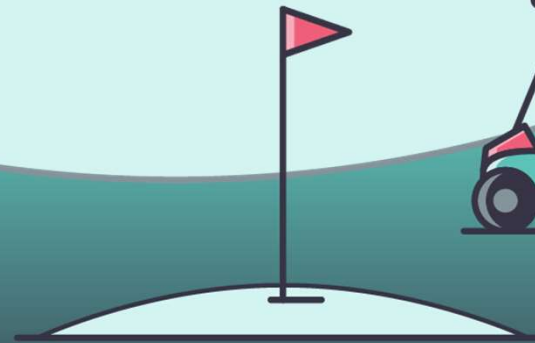

SketchUcation Extension Store Download

- “Window,” “Extension Manager”
- Manage Loaded Extensions
- Update Some Extensions
 - (Notification on SketchUp Load)
- Uninstall Extensions

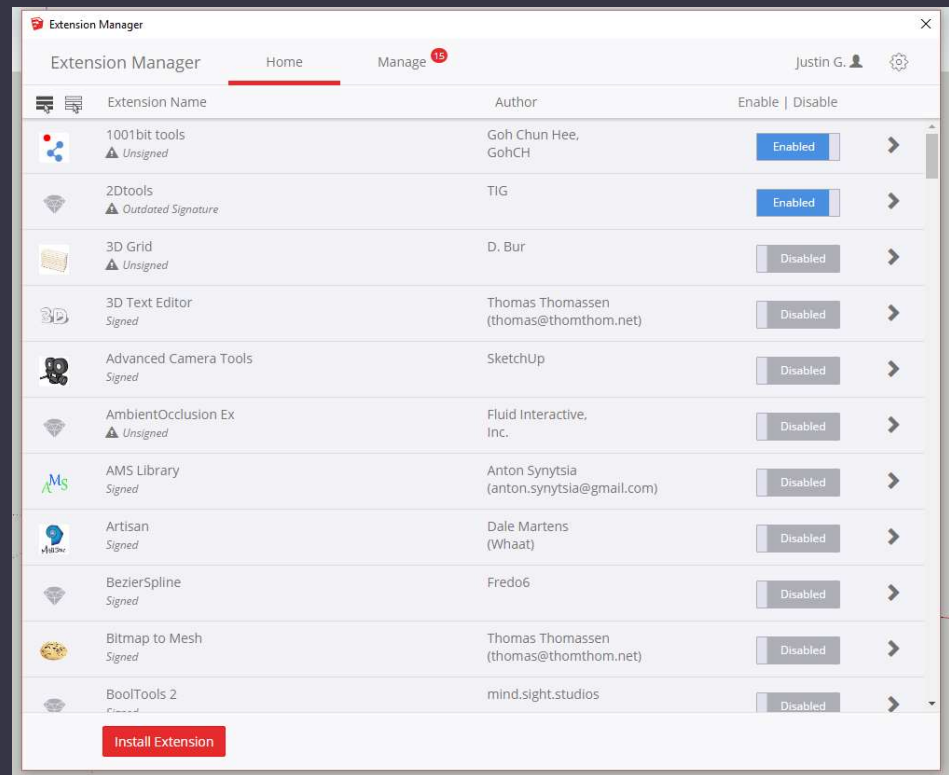

Installing Extensions Manually

- Install Extension Button
 - Select the Ruby File you've downloaded
- Enable Extension
- May have to restart SketchUp

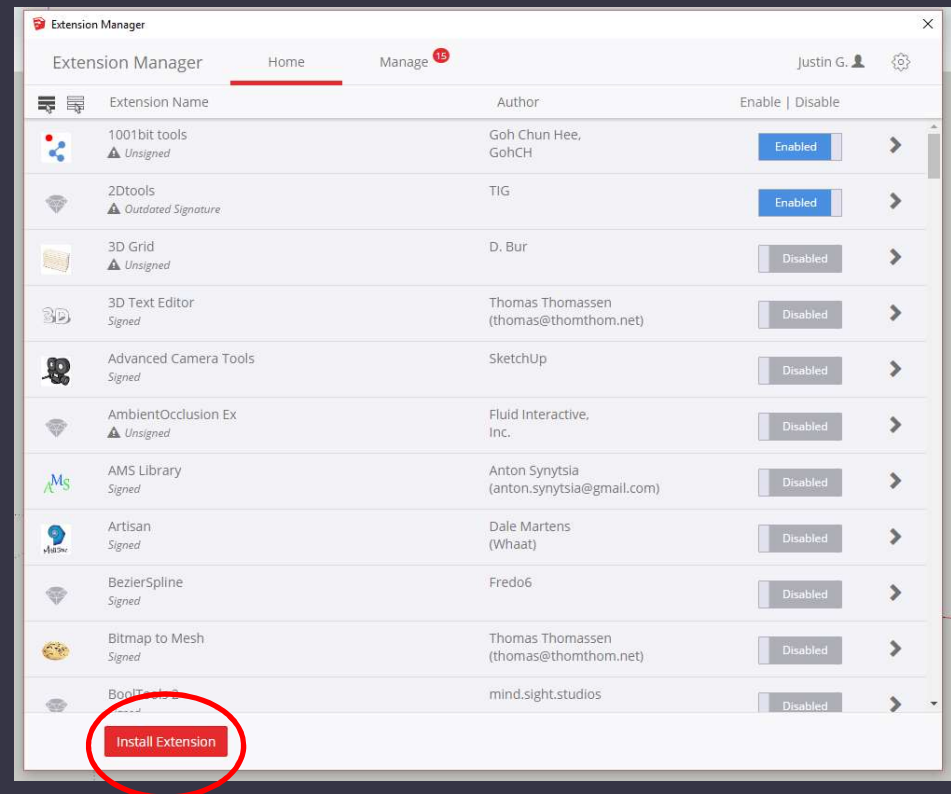

Loading Policy

- Checks for a specific digital signature by registered Sketchup Developers
- Usually set to “unrestricted,” just make sure you trust the location you got your extension from

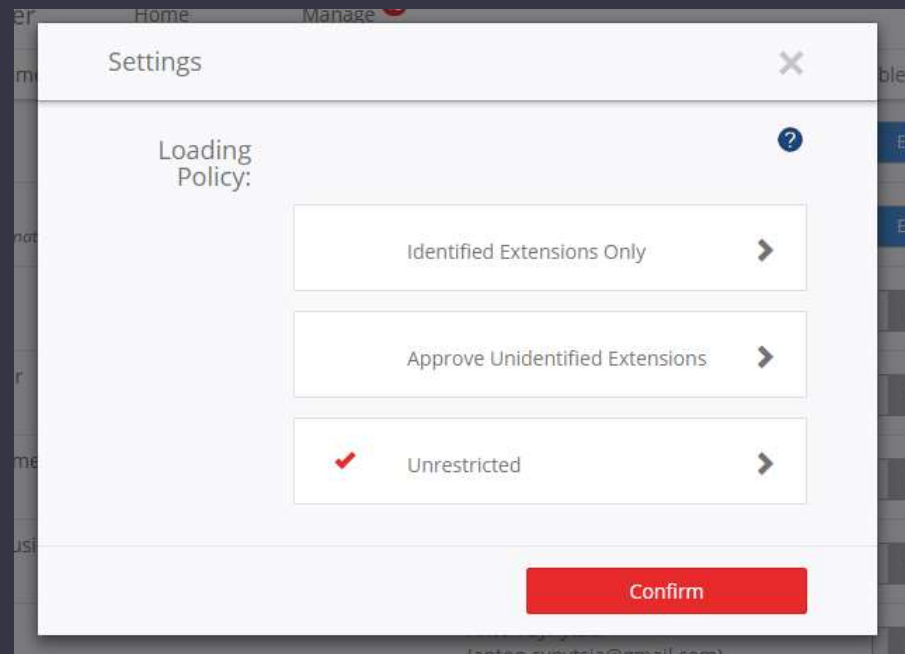

Extensions and SketchUp Speed

- Every extension SketchUp has to load will slow down your load time
- Load only the extensions you need

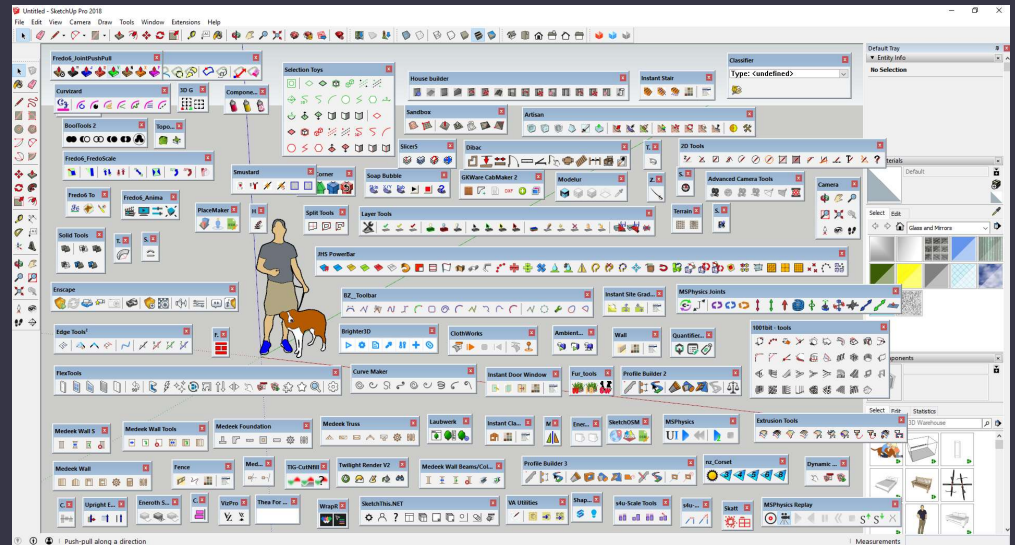

PLEASE Don't do this



What Kind of Extensions are There?



Add Simple Functions to SketchUp

- Curic Space/Curic Align
- Weld
- 3D Text Editor
- Selection Toys
- Eneroth Visual Merge
- Many Many More

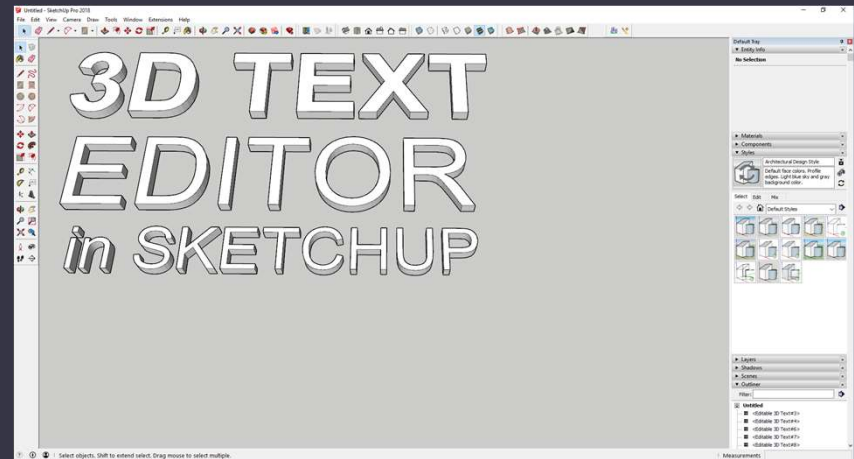
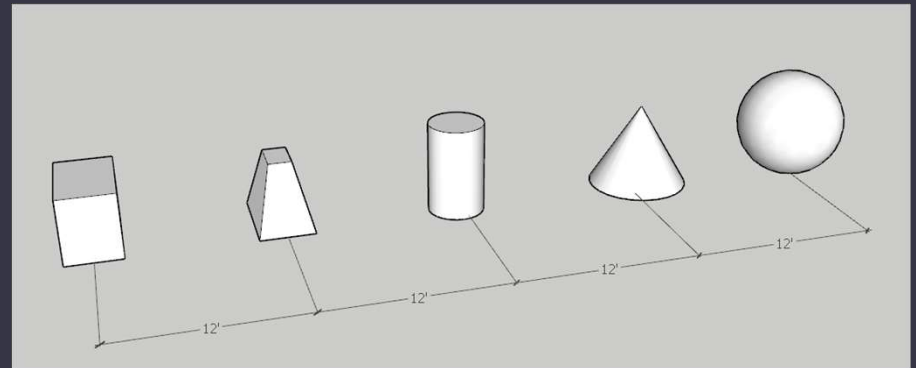

Architectural Extensions

- Profile Builder
- Flex Tools
- PlusSpec (BIM in SketchUp)
- Medeek Wall/Truss/Foundation
- 2D Tools
- 1001Bit Tools

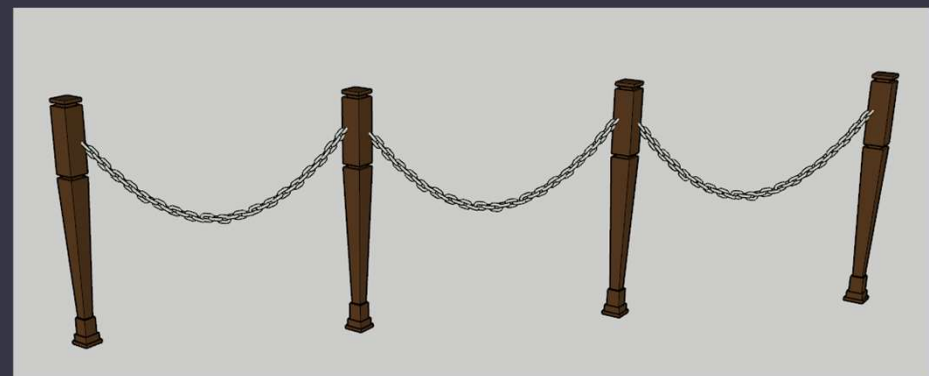
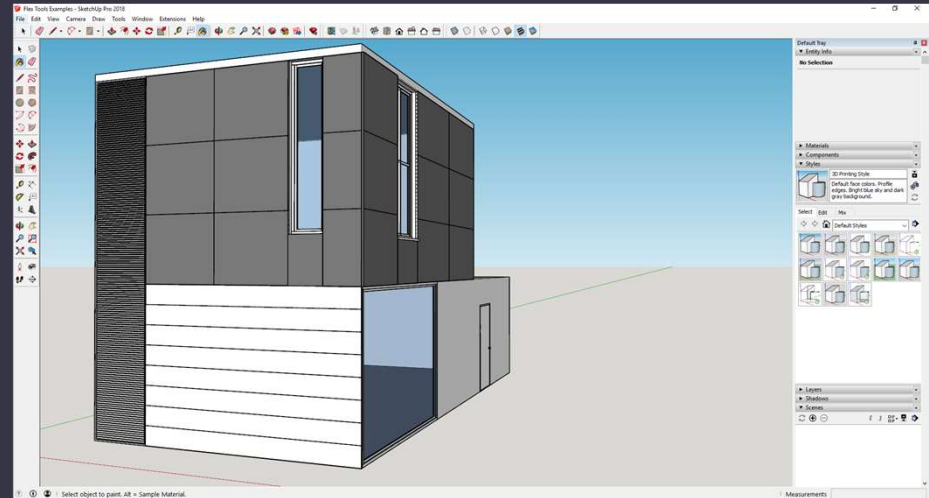

Site/Location Extensions

- Placemaker
- Instant Road
- Skatter
- Sandbox Tools
- Toposhaper
- Edge Tools

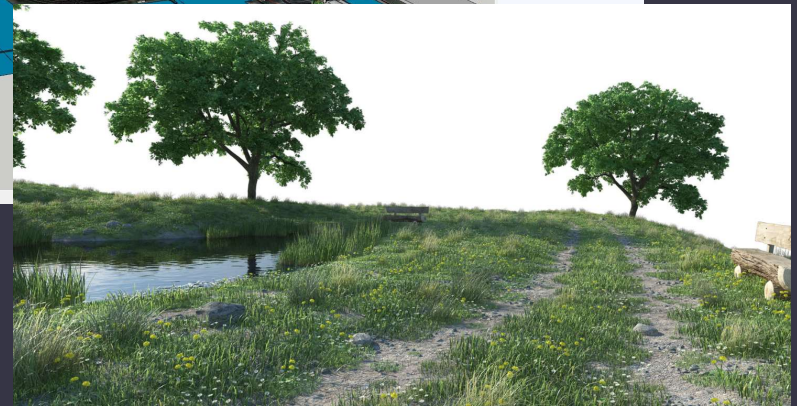
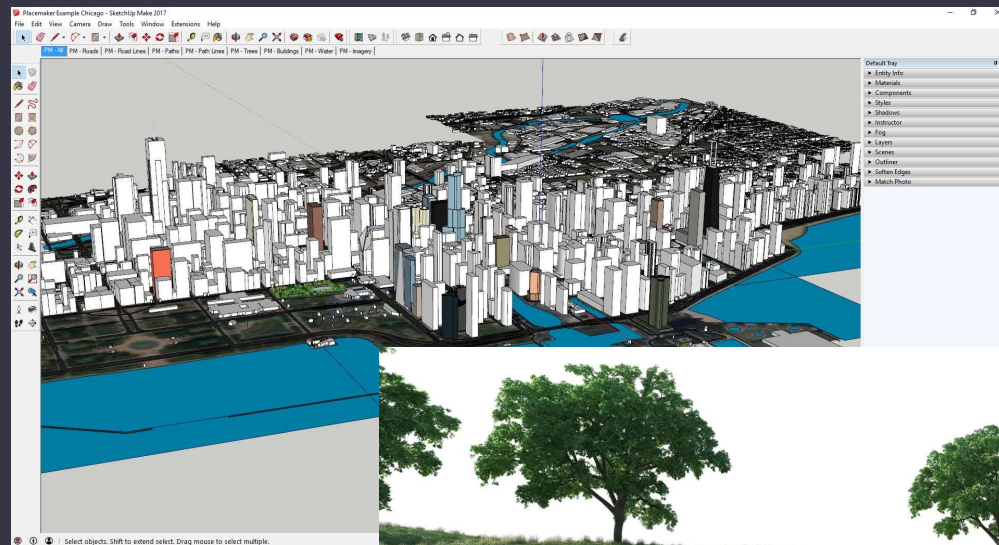

Photorealistic Rendering

- Enscape
 - (Image Credit: Archoverdose from Enscape Forum)
- Vray
- SketchFX
- Twilight Render (Free)
- Thea Render
- Many More



Interior Design/Woodwork

- GKWare Cabinet Maker
- Floor Generator
- CabWriter
- EasySketch Kitchen Design
- CutList

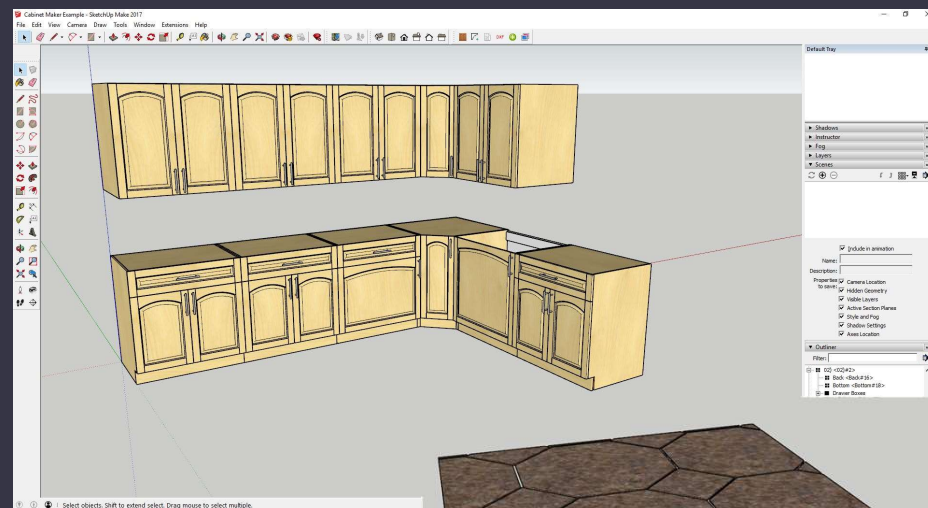

Complex Models/Organic Modeling

- Curviloft
- Joint Push Pull
- FredoScale
- Helix Along Curve
- Flowify
- SubD/Artisan

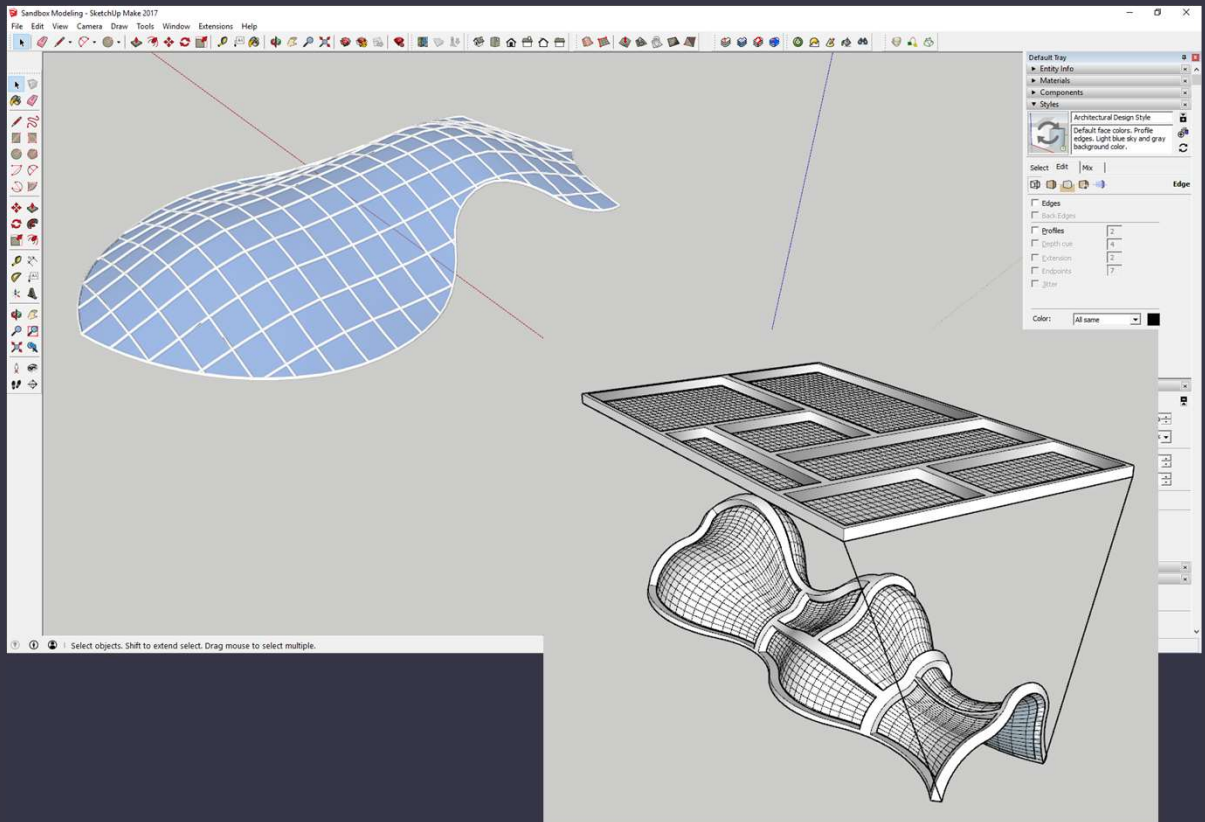

Other Applications

- Clothworks
- MS Physics
- Animator
- Laubwerk

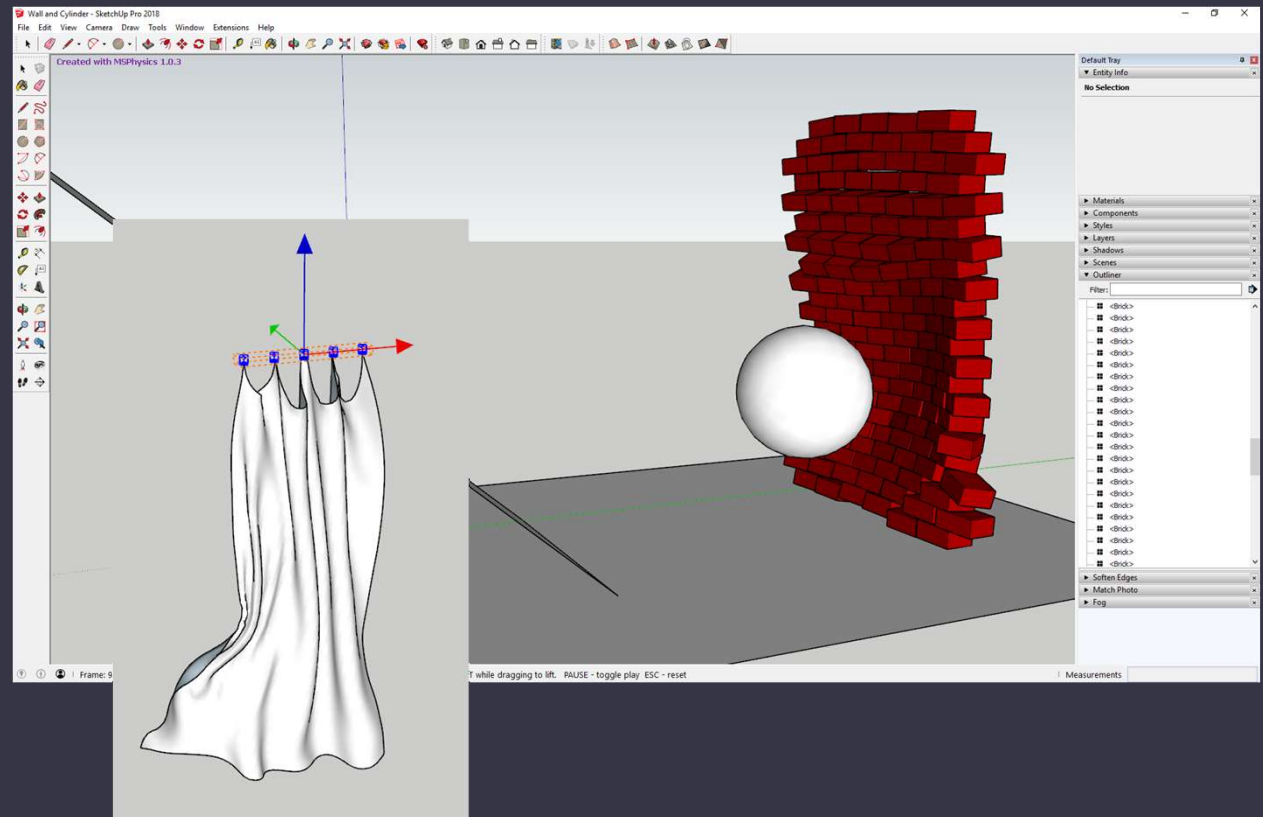



Extension Workshop



Sandbox Tools

Site and Face Editing Tools

- Built-In to SketchUp
- Suite of tools for doing sitework in SketchUp
- “Window,” “Extension Manager,” “Enable Sandbox Tools”

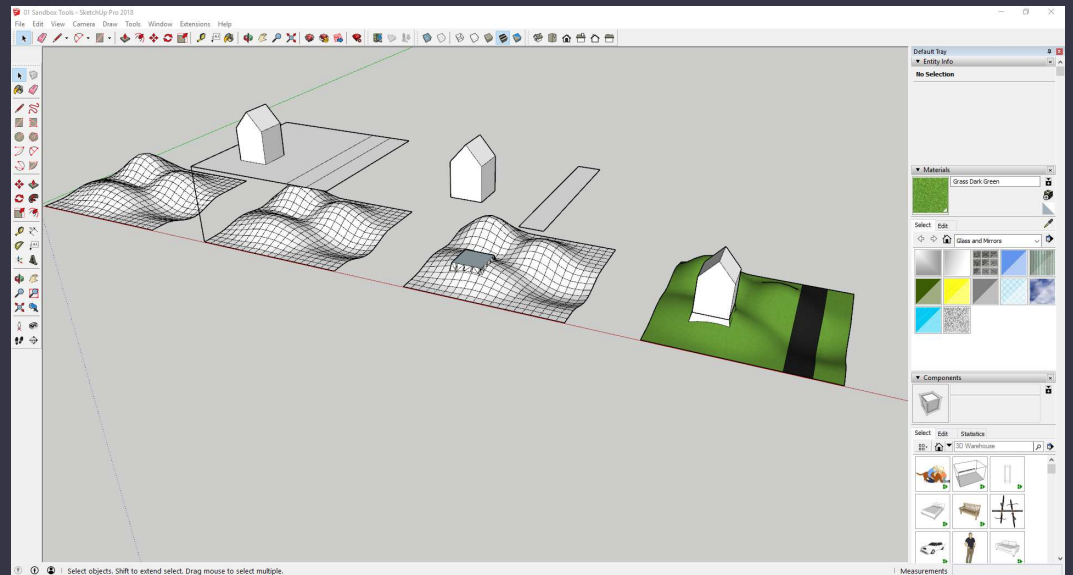

Selection Toys

Powerful Selection Tool

- Developer: Thom Thom
- Cost: Free
- Location: SketchUp Extension Warehouse
- Install “tt_selection_toys-2.4.0”

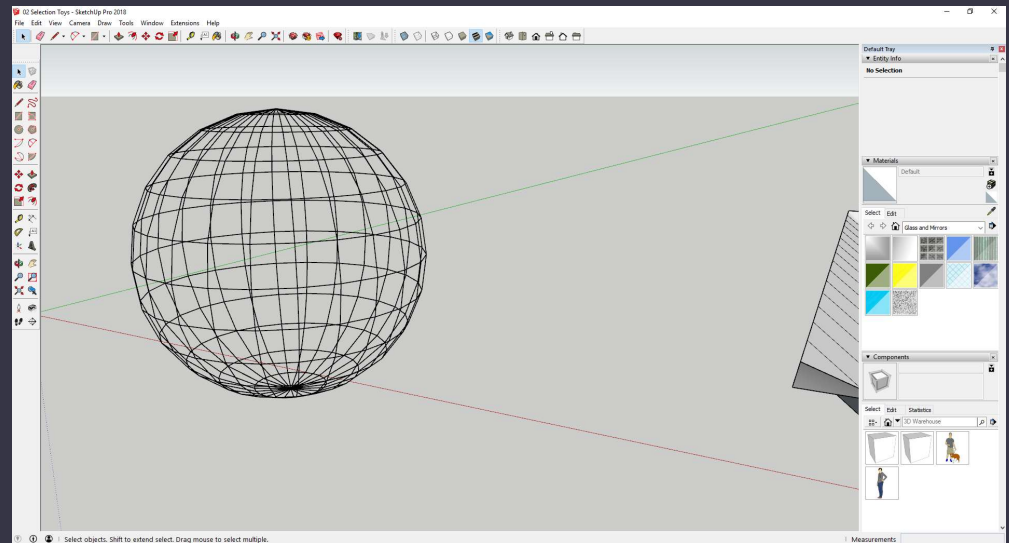

Weld

Join individual line segments into a single line

- Developer: Smustard Team
- Cost: Free
- Location: SketchUp Extension Warehouse
- Install “smustard_Weld_7”

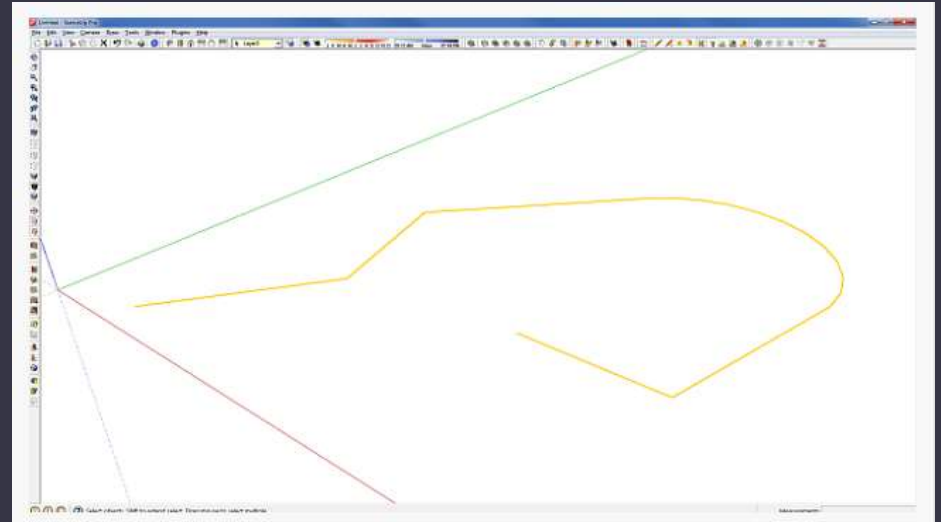

PathCopy

Copy objects along a path

- Developer: Smustard Team
- Cost: Free
- Location: SketchUp Extension Warehouse
- Install
“smustard_PathCopy_7”

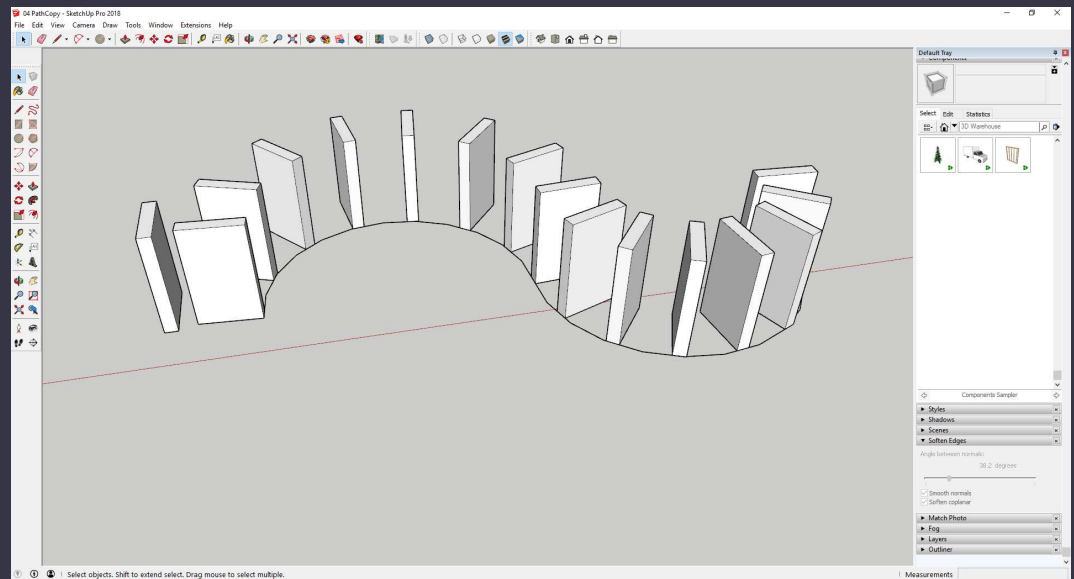

DropGC

Drop Objects onto Irregular Shapes

- Developer: Smustard Team
- Cost: Free
- Location: SketchUp
Extension Warehouse
- Install
“smustard_DropGC_9”

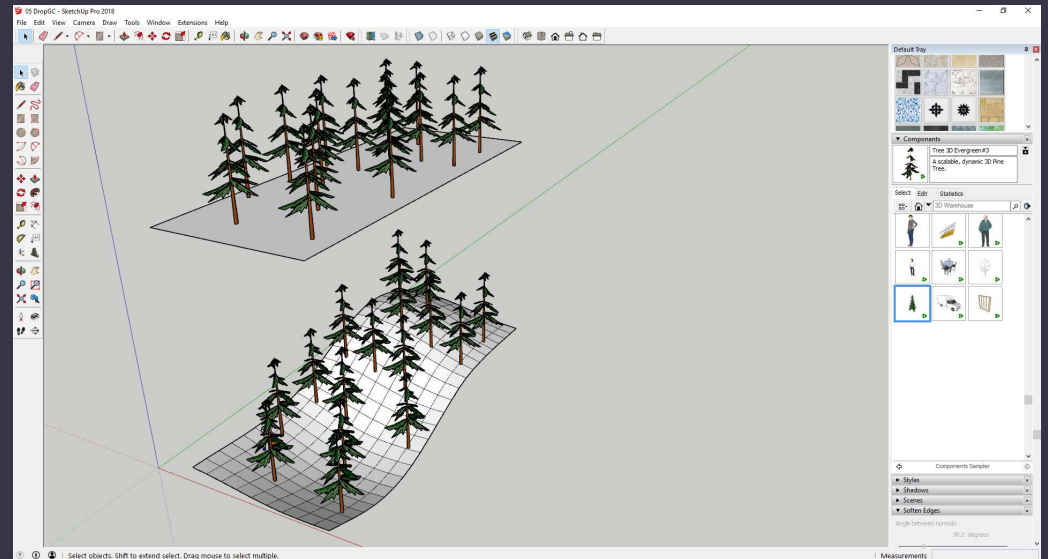

TIG Roof

Create Roofs from Faces in SketchUp

- Developer: TIG
- Cost: Free
- Location: SketchUcation Extension Warehouse
- Install “Roof_v5.0”

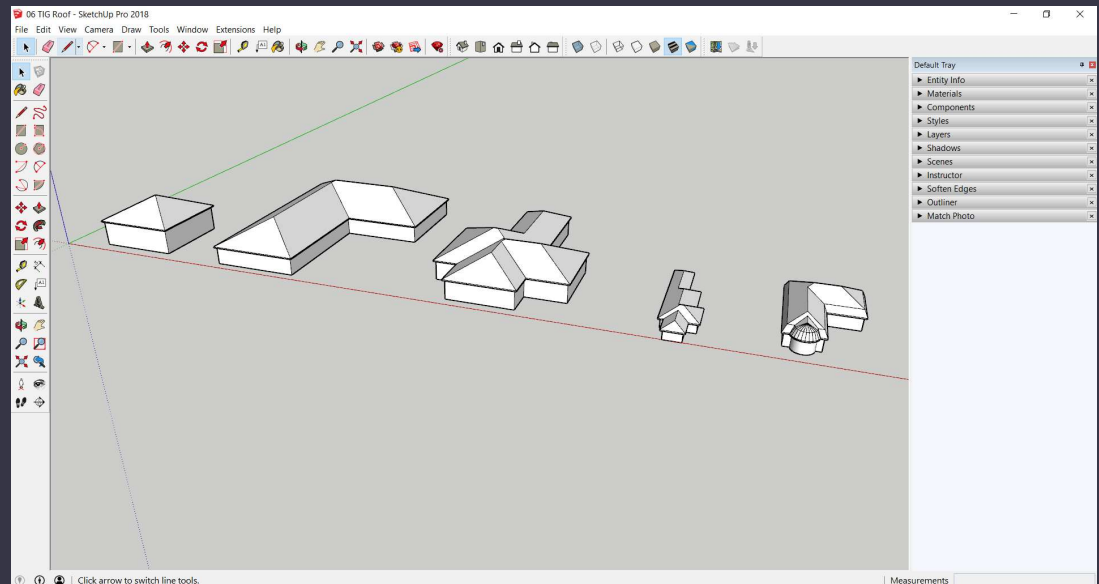

1001Bit Tools

Suite of Architectural Tools

- Developer: Goh Chun Hee
- Cost: Free
- Location: SketchUcation Extension Warehouse
- Install
“1001bit_freeware_v1.0.3_v1.0.5”
- ...Technically not supported in SketchUp 2018...

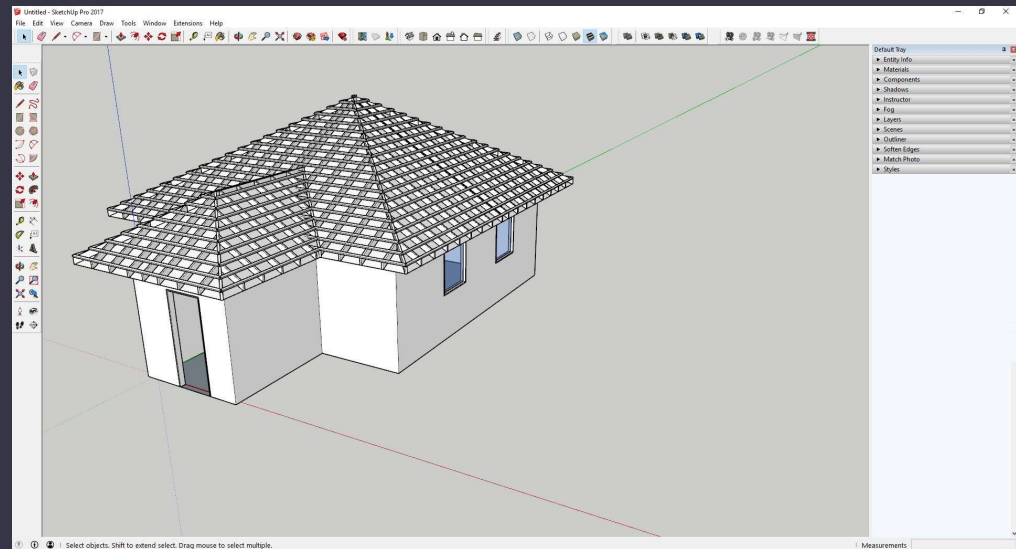

Shape Bender

Tool for Bending Objects Along Curves

- Developer: Chris Fullmer
- Cost: Free
- Location: SketchUp
Extension Warehouse
- Install “clf_shape_bender_0-6-1_0”

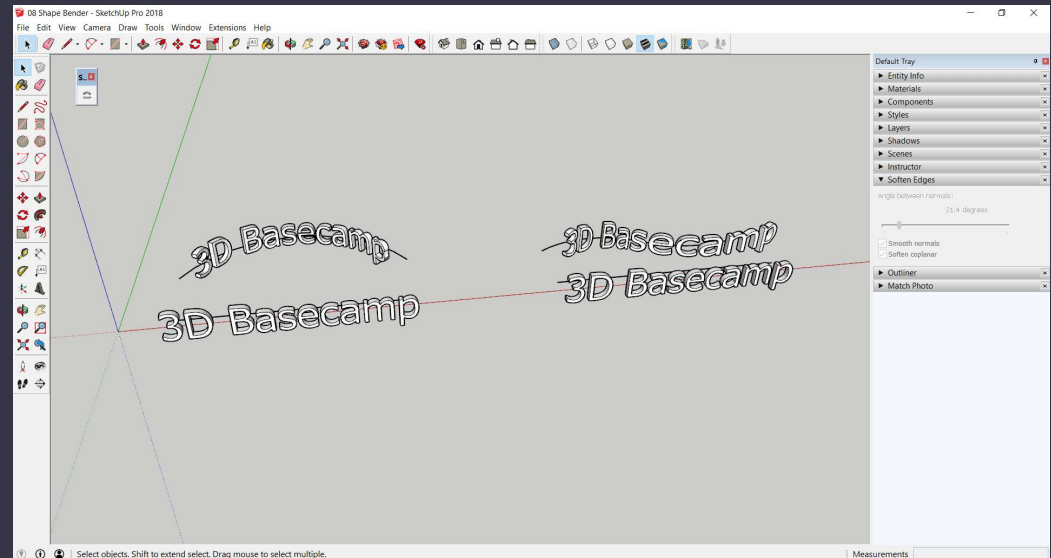

2D Tools

Suite of Tools for 2D Modeling

- Developer: TIG
- Cost: Free
- Location: SketchUcation Extension Warehouse
- Install “2Dtools_v7.6”

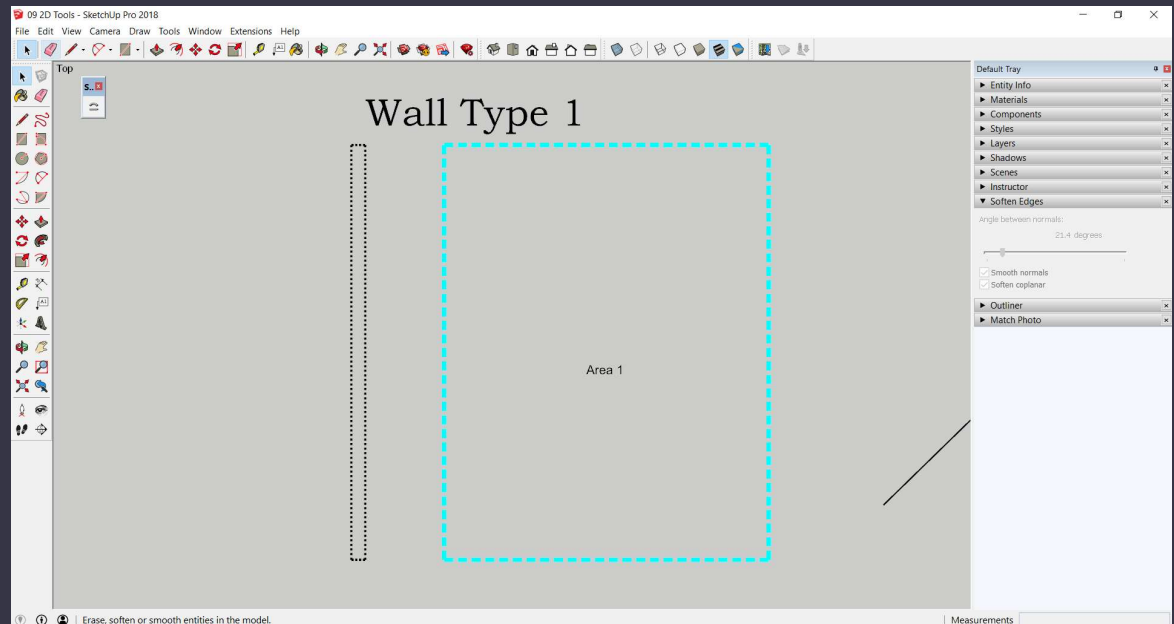

Tutorials and Links for all these extensions at
www.thesketchupessentials.com/Basecamp2018

Justin@thesketchupessentials.com

[YouTube.com/TheSketchUpEssentials](https://www.youtube.com/TheSketchUpEssentials)

