

# Extension Madness

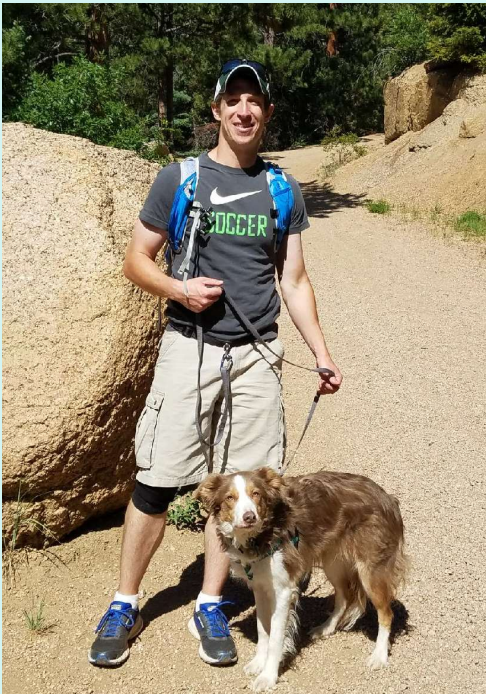

**3DBASECAMP**  
2018  
Palm Springs





# Justin Geis

[TheSketchUpEssentials.com](http://TheSketchUpEssentials.com)

- [YouTube.com/TheSketchUpEssentials](https://www.youtube.com/TheSketchUpEssentials)

- The SketchUp Essentials YouTube Channel -

Almost 500 videos now about how to use SketchUp

Weekly SketchUp extension introduction and review videos



## Resources from Today's Presentation

- [www.TheSketchUpEssentials.com/Basecamp2018](http://www.TheSketchUpEssentials.com/Basecamp2018)
- This presentation
- Links to tutorials on every extension I mention





**My Goal -**

**Everyone in this room learns about at least one extension that's going to make their work significantly easier**



# Presentation Agenda

- What are Extensions?
- How to get them
- Overview of available extensions
- Extension Workshop



# What are extensions and Why do you need them?



# How long do you think this took to model?

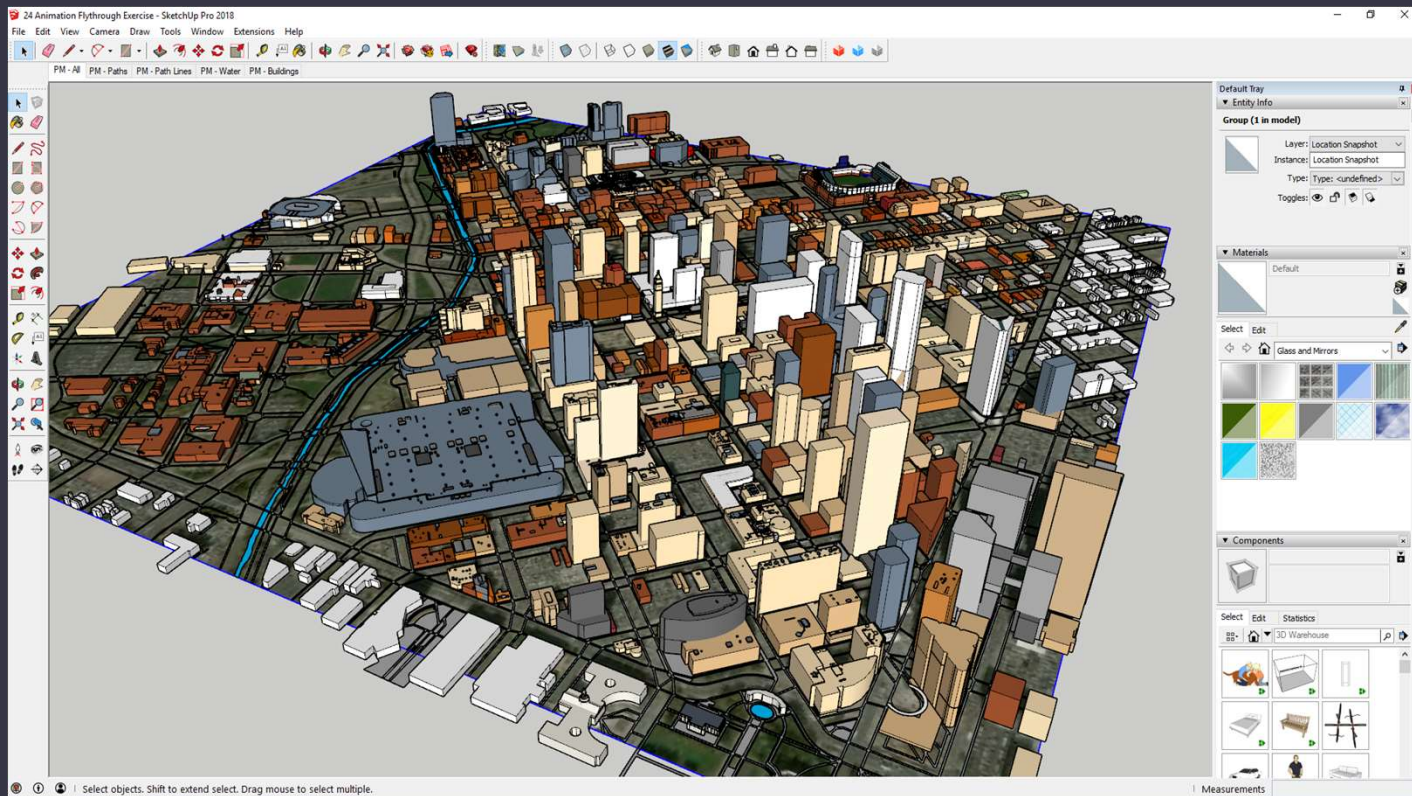



# How would you make this in SketchUp?

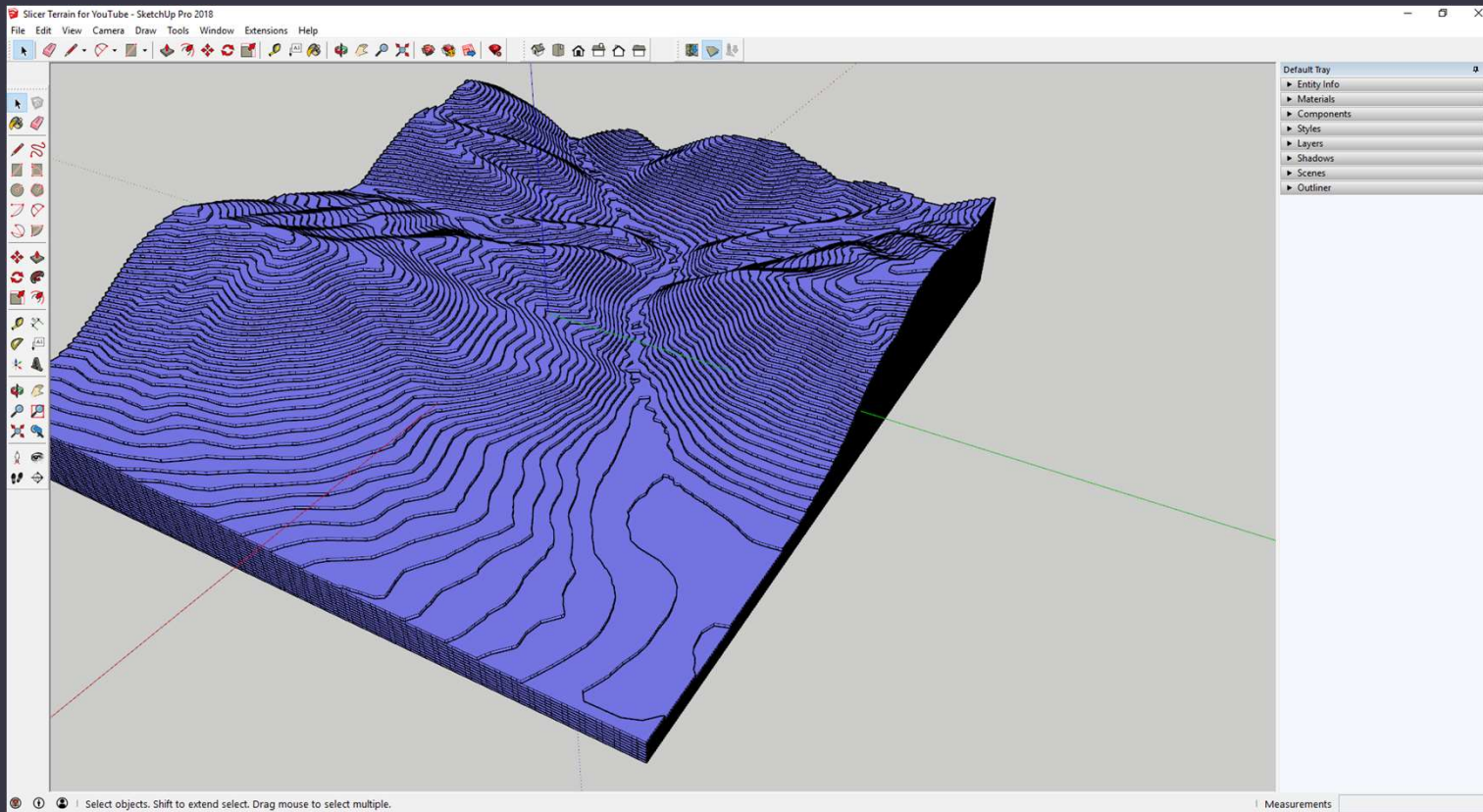



**Did you think this was possible in SketchUp?**





## What are extensions?

- Extensions are basically scripts that you install in SketchUp to expand its functionality
- Written in a language called Ruby
- Only available in the desktop version of SketchUp



**How many of you are using extensions right now in your workflow?**







**The goal should always be to make modeling in SketchUp faster and more efficient.**

**Extensions are how you get faster and more efficient**



## What kinds of extensions are available?

- General Tools
- Architecture
- Woodworking
- BIM
- 3D Rendering
- Location Modeling
- Interior Design
- Organic Modeling
- Construction
- Animation
- And more!



# Where to get extensions

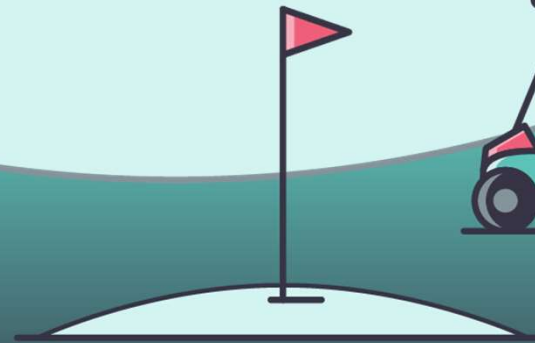
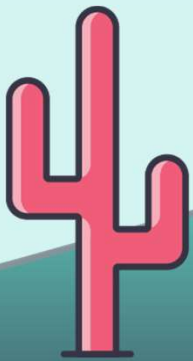

# Where to Get Extensions #1

## The SketchUp Extension Warehouse

- “Window”, “Extension Warehouse” within SketchUp
- Need to create a Trimble ID or you can use your Google Account
- Search for extensions by name, by category, or by developer

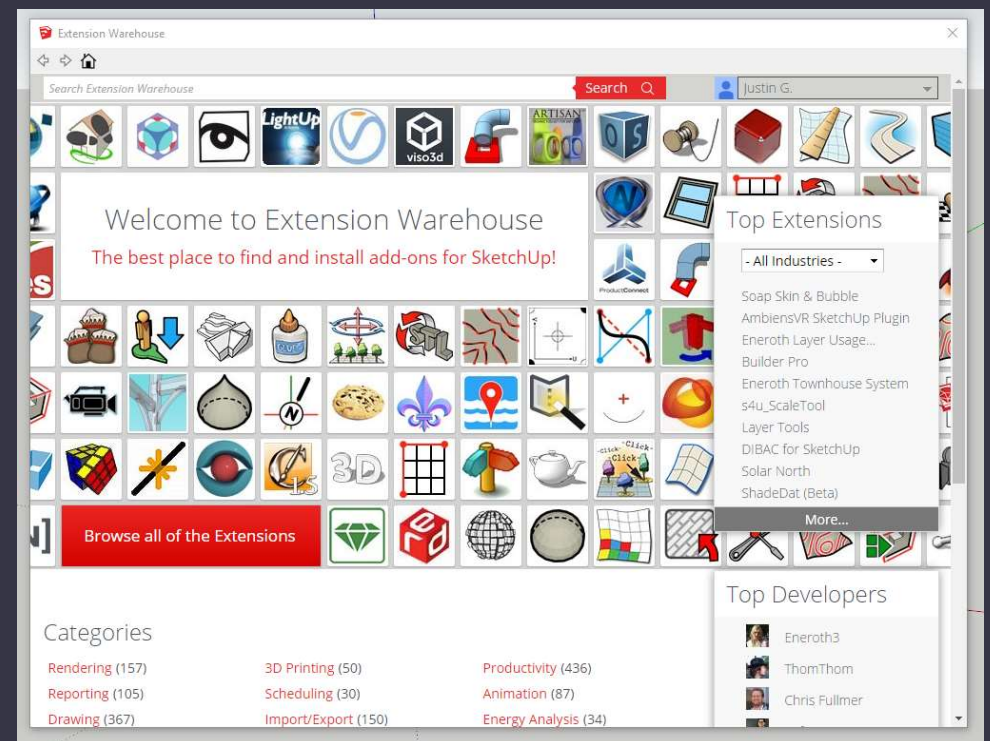

# SketchUp Extension Information Page

- Name/Developer
- Reviews
- Instructions (Sometimes Video)
- SketchUp Compatibility – Very Important!
- Install/Update Button

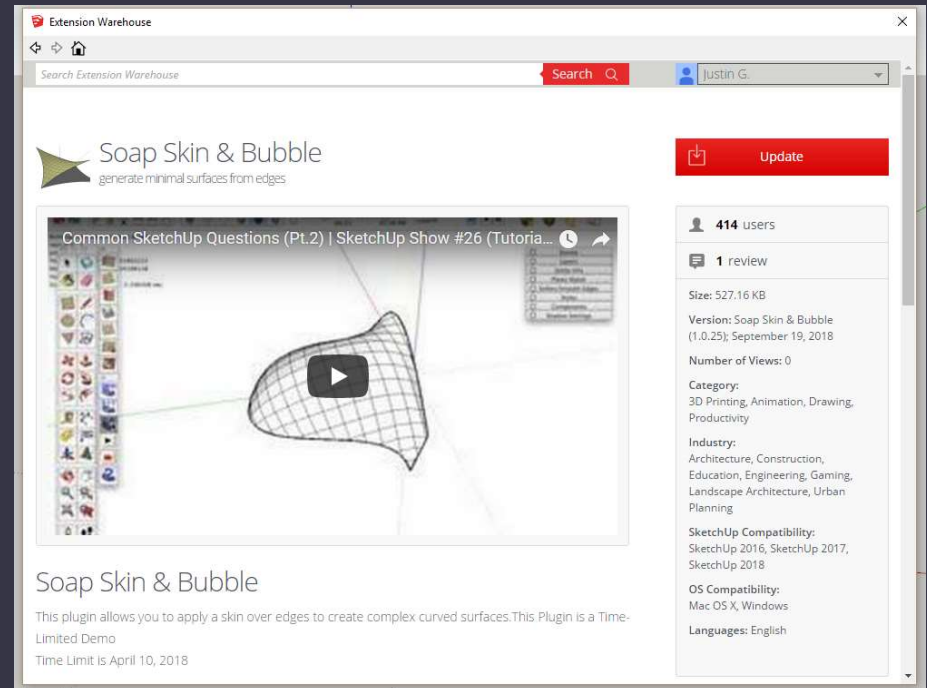

The screenshot shows the 'Soap Skin & Bubble' extension page on the SketchUp Extension Warehouse. The page features a search bar at the top with the text 'Search Extension Warehouse' and a search icon. The extension name 'Soap Skin & Bubble' is displayed with a green and yellow logo and the tagline 'generate minimal surfaces from edges'. A red 'Update' button is visible in the top right corner. Below the extension name is a video player showing a 3D model of a curved surface. The video title is 'Common SketchUp Questions (Pt.2) | SketchUp Show #26 (Tutoria...'. To the right of the video player, there is a sidebar with user statistics: '414 users' and '1 review'. Below the statistics, the extension details are listed: 'Size: 527,16 KB', 'Version: Soap Skin & Bubble (1.0.25); September 19, 2018', 'Number of Views: 0', 'Category: 3D Printing, Animation, Drawing, Productivity', 'Industry: Architecture, Construction, Education, Engineering, Gaming, Landscape Architecture, Urban Planning', 'SketchUp Compatibility: SketchUp 2016, SketchUp 2017, SketchUp 2018', 'OS Compatibility: Mac OS X, Windows', and 'Languages: English'. At the bottom of the page, there is a description: 'This plugin allows you to apply a skin over edges to create complex curved surfaces. This Plugin is a Time-Limited Demo. Time Limit is April 10, 2018'.

# Where to Get Extensions #2

## The SketchUcation Extension Warehouse

- www.SketchUcation.com
- Will need a Login
  - Use the Free Account Option!
- Similar search function to the SketchUp Extension Warehouse
- Available as a plugin to SketchUp as well

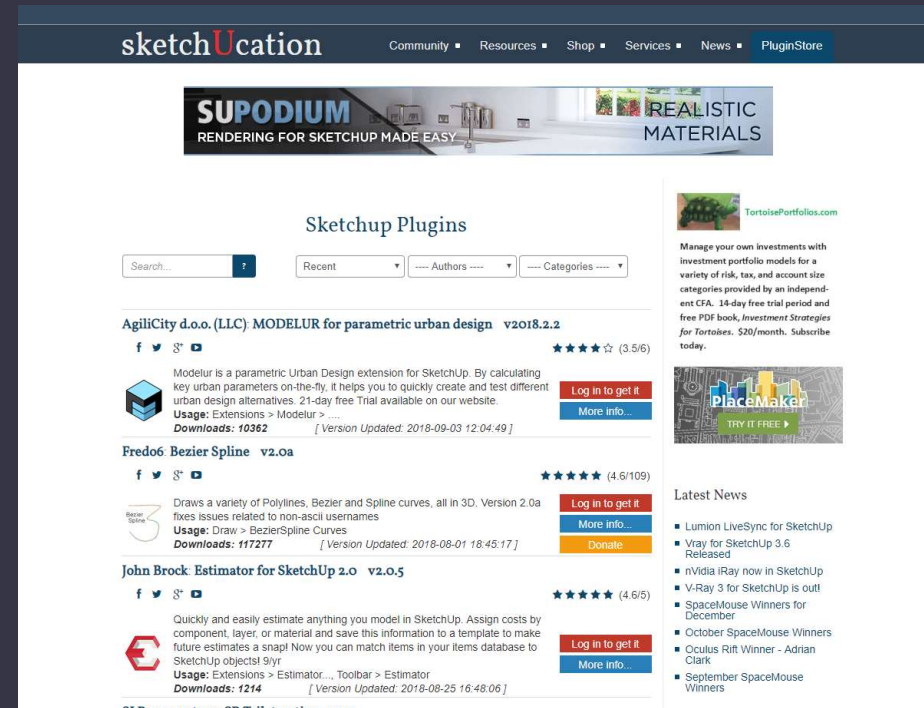

The screenshot shows the SketchUcation website interface. At the top, there is a navigation bar with the logo "sketchUcation" and menu items: "Community", "Resources", "Shop", "Services", "News", and "PluginStore". Below the navigation bar is a banner for "SUPODIUM" with the tagline "RENDERING FOR SKETCHUP MADE EASY" and "REALISTIC MATERIALS". The main content area is titled "Sketchup Plugins" and features a search bar and filters for "Recent", "Authors", and "Categories". A list of plugins is displayed, including:

- AgiliCity d.o.o. (LLC) MODELUR for parametric urban design v2018.2.2**: A parametric Urban Design extension for SketchUp. It includes a search bar, social media icons, a star rating of 3.5/5, and buttons for "Log in to get it" and "More info...".
- Fredo6 Bezier Spline v2.0a**: Draws a variety of Polylines, Bezier and Spline curves, all in 3D. It includes a star rating of 4.6/109 and buttons for "Log in to get it", "More info...", and "Donate".
- John Brock Estimator for SketchUp 2.0 v2.0.5**: Quickly and easily estimate anything you model in SketchUp. It includes a star rating of 4.6/5 and buttons for "Log in to get it" and "More info...".

On the right side of the page, there is a sidebar with a "Latest News" section listing updates such as "Lumion LiveSync for SketchUp", "Way for SketchUp 3.6 Released", and "nVidia iRay now in SketchUp".

# SketchUcation Extension Information Page

- Name/Developer
- Dependencies
- Install/Update Button
- **CLICK THE MORE INFO BUTTON!**

**Sketchup Plugins**

Search... ? Recent --- Authors --- Categories ---

**Fredo6: Animator v2.2c** ★★★★★ (4.2/43)

f t g+ v

Animator is a script dedicated to the animation of Sketchup models. It provides a parametric, interactive framework to control movements of objects and cameras along a timeline. Animator generates videos in various formats.

**Usage:** Tools > Fredo6 Collection > Animator

**Dependencies:** LibFredo6 8.4a or higher

**Downloads:** 28712 [ Version Updated: 2018-08-26 21:38:25 ]

Log in to get it  
More info...  
Donate

Tags for this article: [sketchup plugins](#) | [sketchup extensions](#) | [plugin](#) | [plugins](#) | [sketchup](#) | [trimble](#) | [installing plugins](#) | [free sketchup plugins](#) | [free sketchup extensions](#) | [sketchup plugin tutorials](#) | [sketchup extension tutorials](#)

# SketchUcation Extension Store Download

- SketchUcation, Resources, Plugin Store Download
- Downloads a Ruby Script (Extension) file that you can install

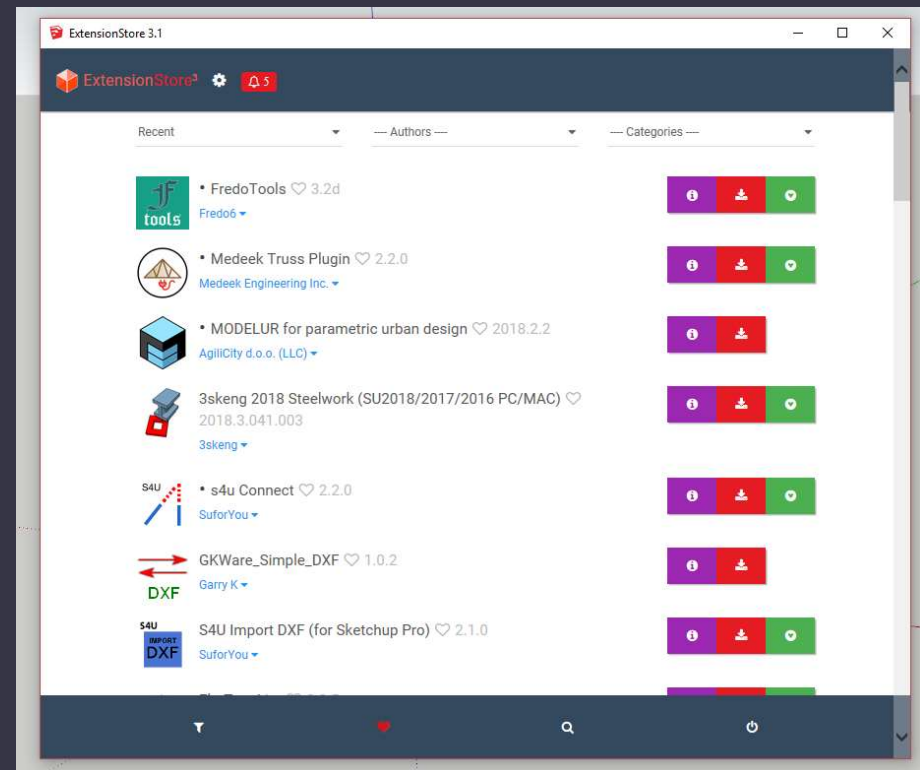

# Where to Get Extensions #3

## Product Websites

- Download Ruby Script Files Directly from Websites
- Install Using Extension Manager
  - Placemaker
  - FlexTools
  - Skatter
  - Many More

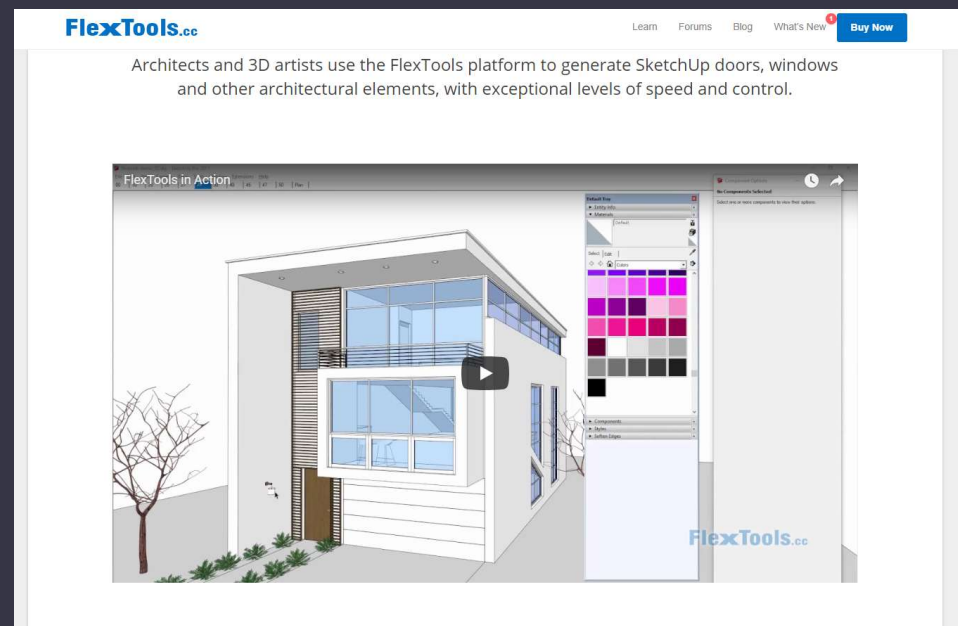



# How to Install Extensions

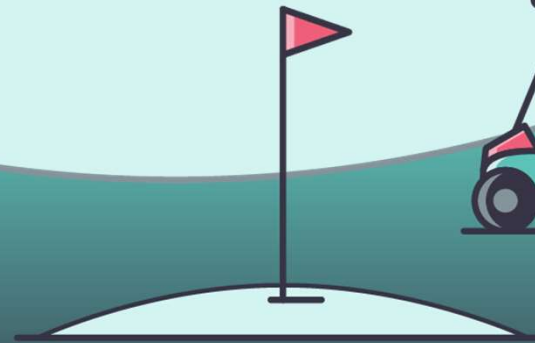

# SketchUp Extension Manager

- “Window,” “Extension Manager”
- Manage Loaded Extensions
- Update Some Extensions
  - (Notification on SketchUp Load)
- Uninstall Extensions

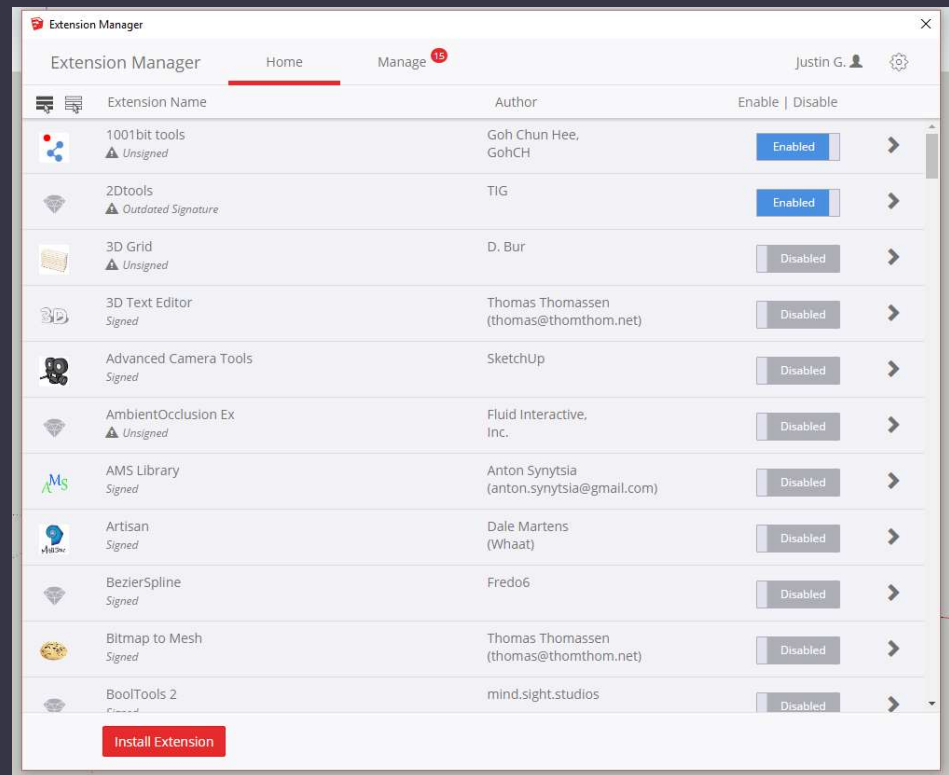

# Installing Extensions Manually

- Install Extension Button
  - Select the Ruby File you've downloaded
- Enable Extension
- May have to restart SketchUp

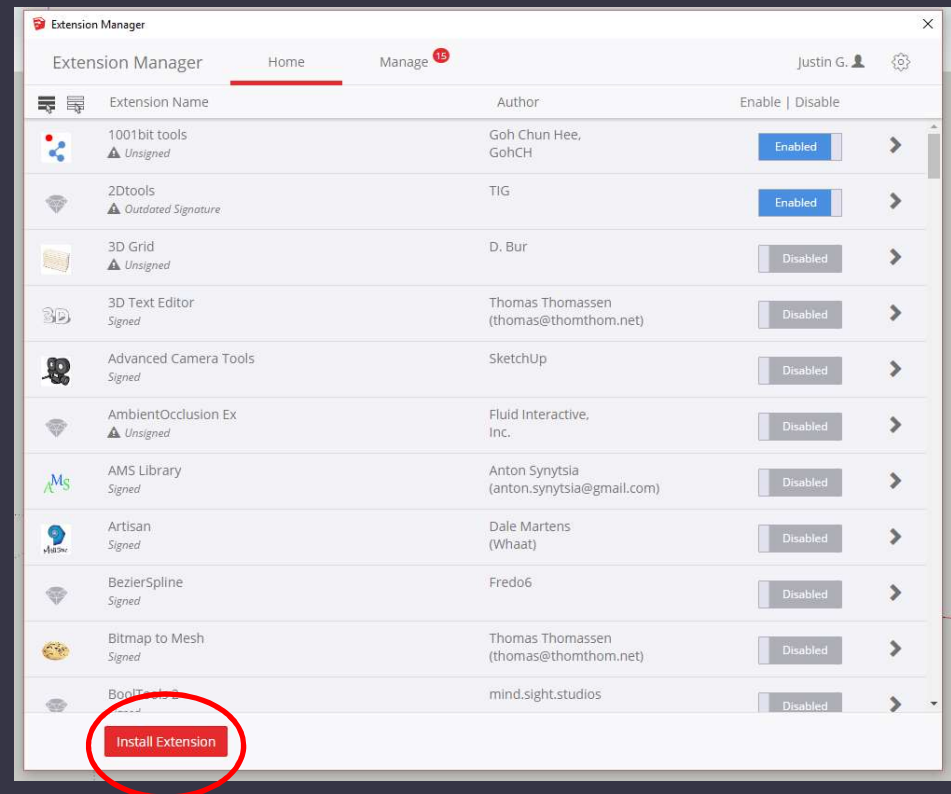

# Loading Policy

- Checks for a specific digital signature by registered Sketchup Developers
- Usually set to “unrestricted,” just make sure you trust the location you got your extension from

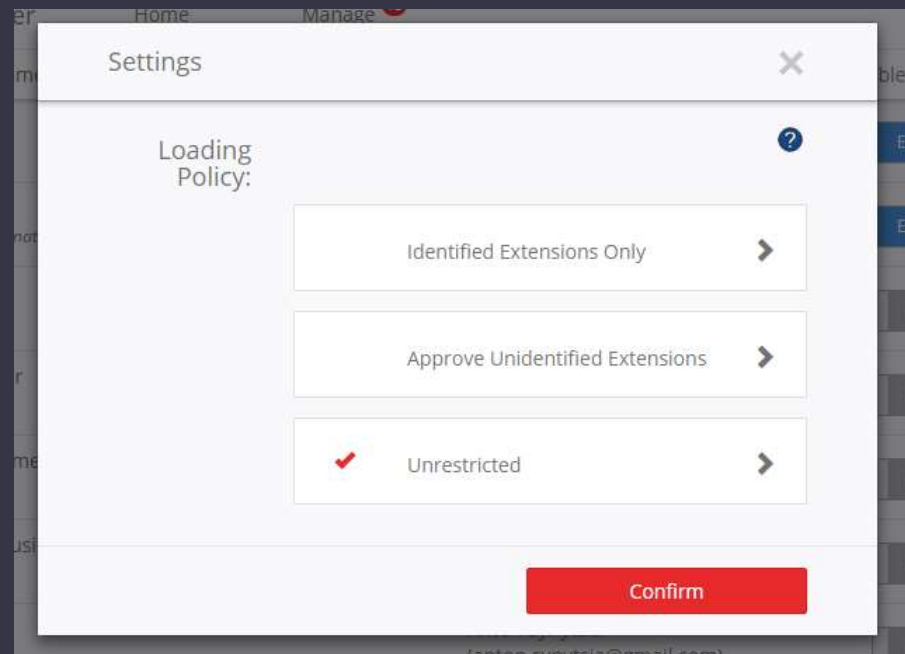

# Turning On Toolbars for Extensions

- PC Version – Right click in toolbar area, find your extension
- Mac Version – I...believe... that you go up to “View,” “Tool Palettes”

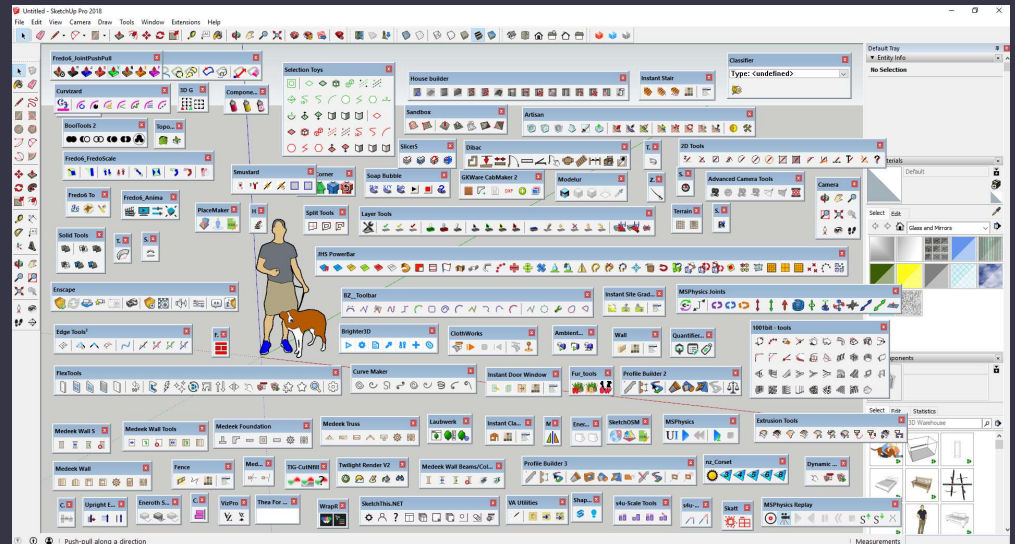

# Extensions and SketchUp Speed

- Every extension SketchUp has to load will slow down your load time
- Load only the extensions you need

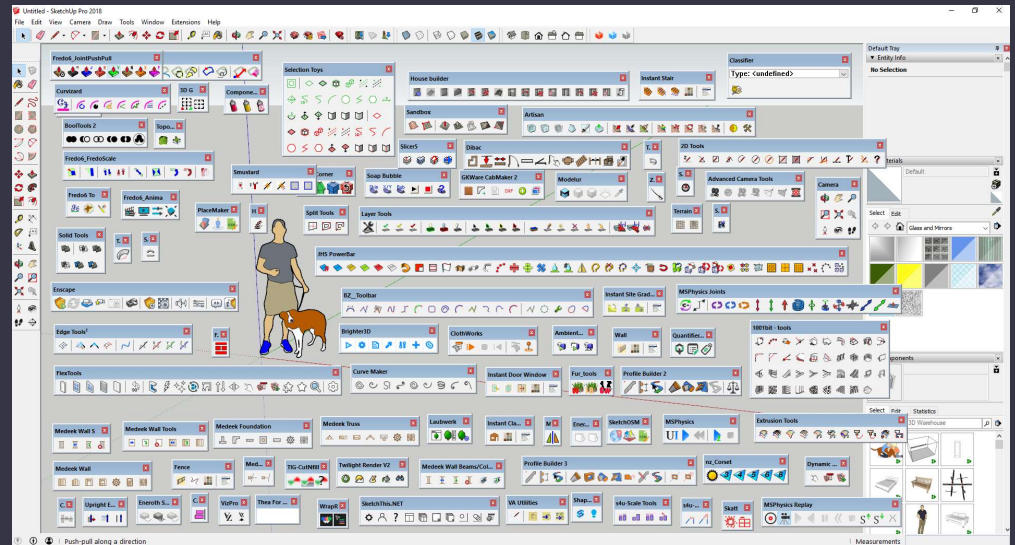

**PLEASE Don't do this**



# Extension Costs







## What Kind of Extensions are There?



# Add Simple Functions to SketchUp

- Curic Space/Curic Align
- Weld
- 3D Text Editor
- Selection Toys
- Eneroth Visual Merge
- Many Many More

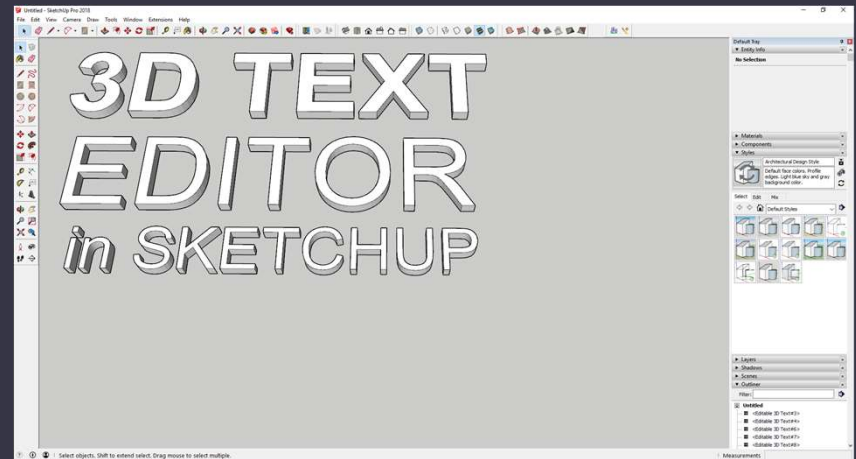
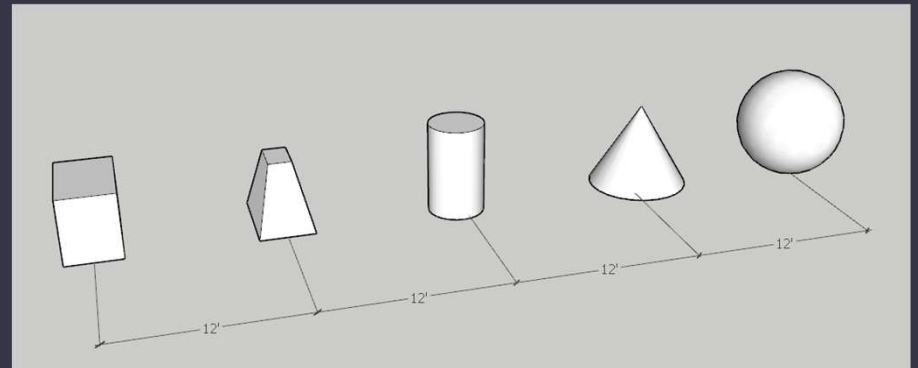

# Architectural Extensions

- Flex Tools
- Profile Builder
- Medeek Wall/Truss/Foundation
- PlusSpec (BIM in SketchUp)
- 1001Bit Tools
- 2D Tools

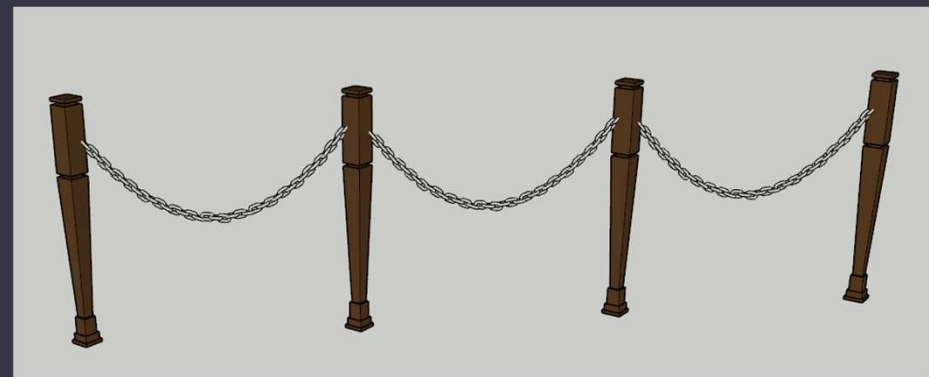
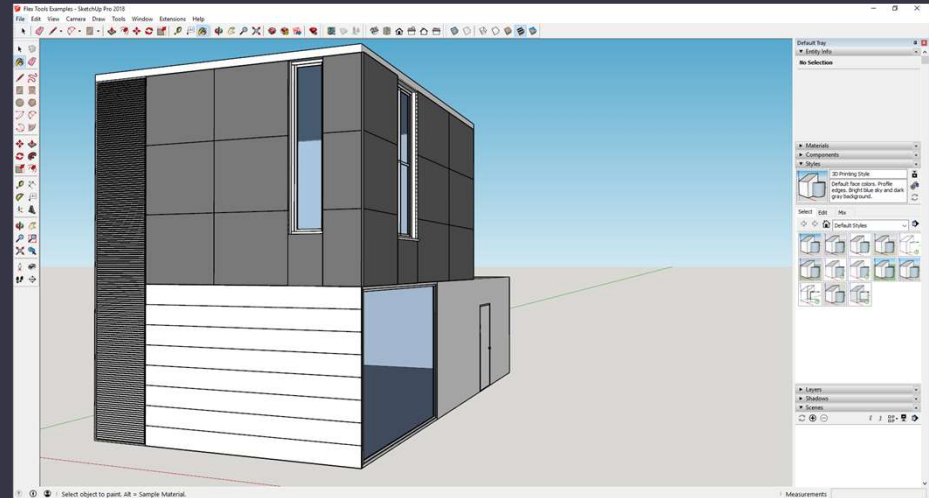

# Site/Location Extensions

- Placemaker
- Sandbox Tools
- Instant Road
- Toposhaper
- Edge Tools
- Skatter

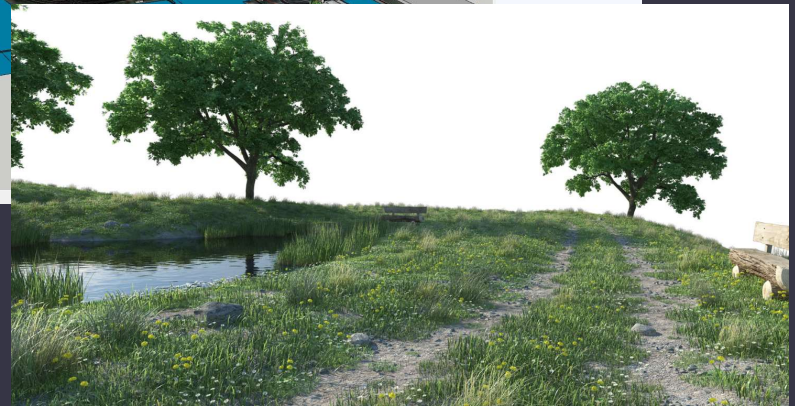
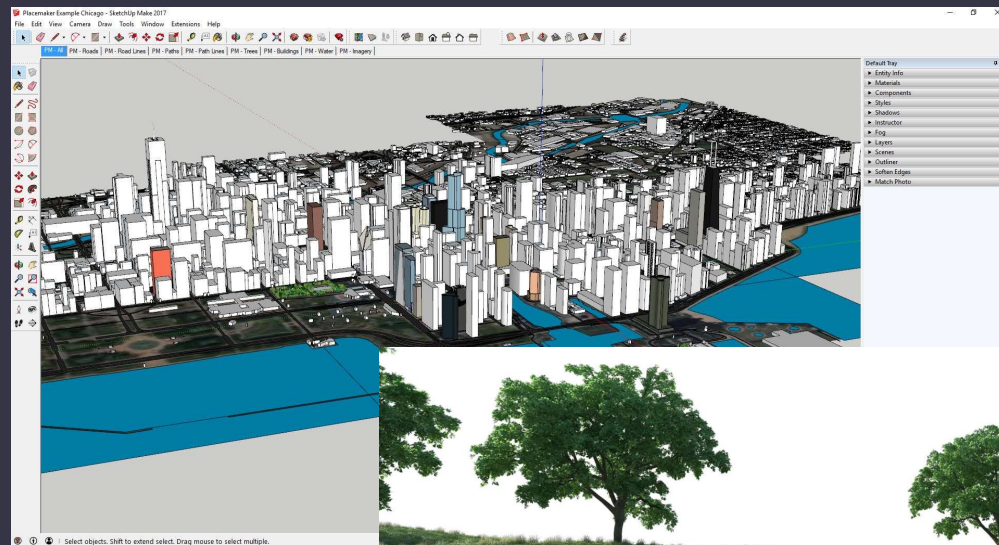

# Interior Design/Woodwork

- GKWare Cabinet Maker
- Floor Generator
- CabWriter
- EasySketch Kitchen Design
- CutList

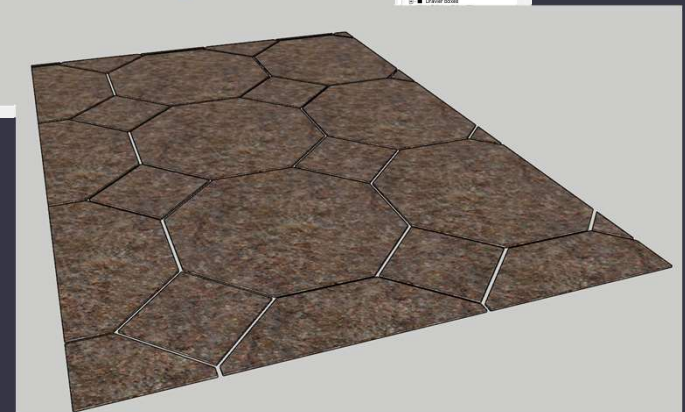
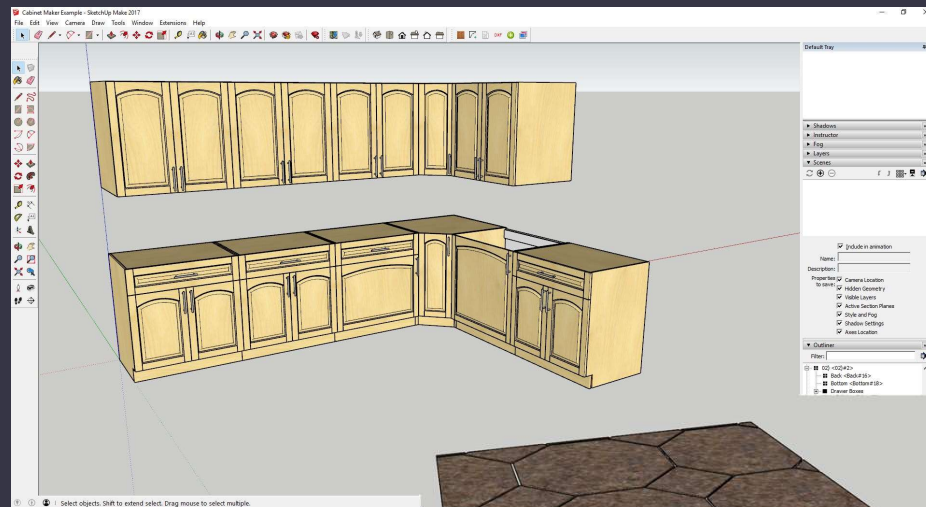

# Complex Models/Organic Modeling

- Curviloft
- Joint Push Pull
- FredoScale
- Helix Along Curve
- Flowify
- SubD/Artisan

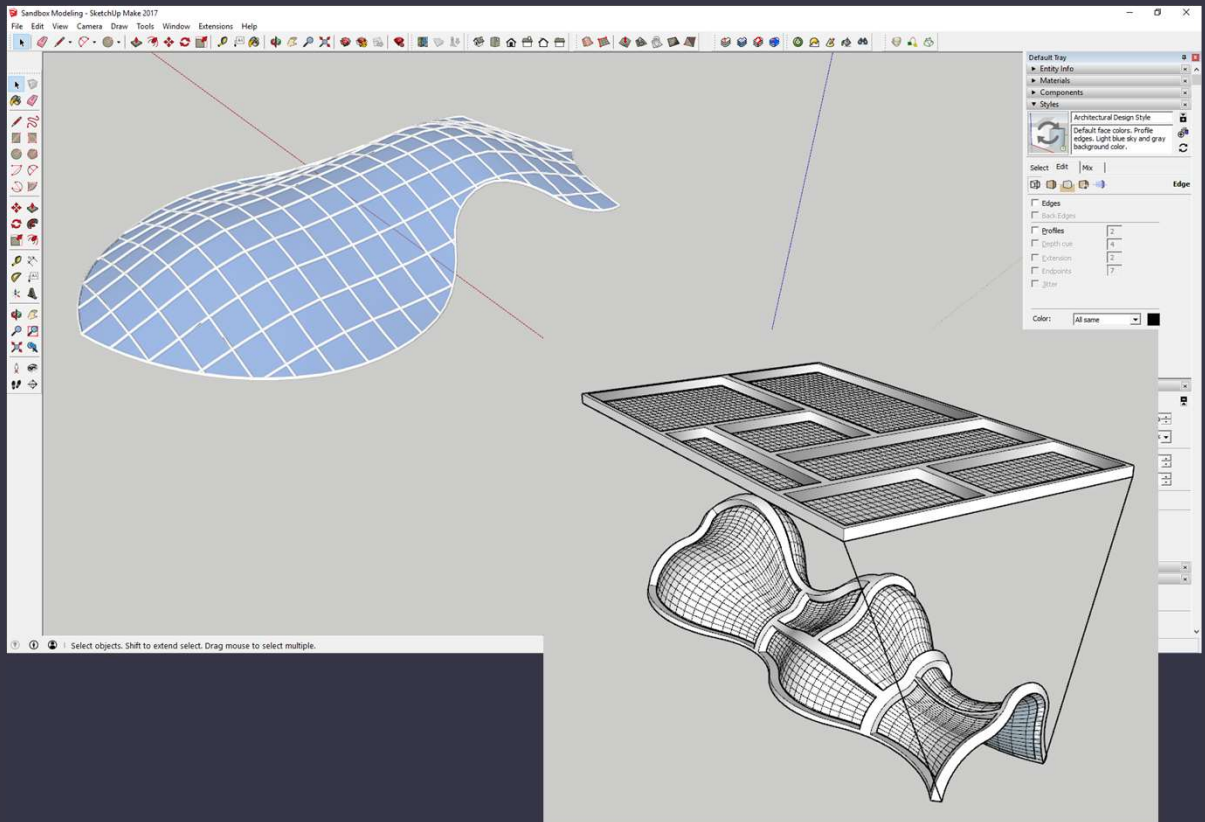



# Photorealistic Rendering

- Enscape
  - (Image Credit: Archoverdose from Enscape Forum)
- Vray
- SketchFX
- Twilight Render (Free)
- Thea Render
- Podium
- Many More



# Other Applications

- Clothworks
- MS Physics
- Animator
- Laubwerk

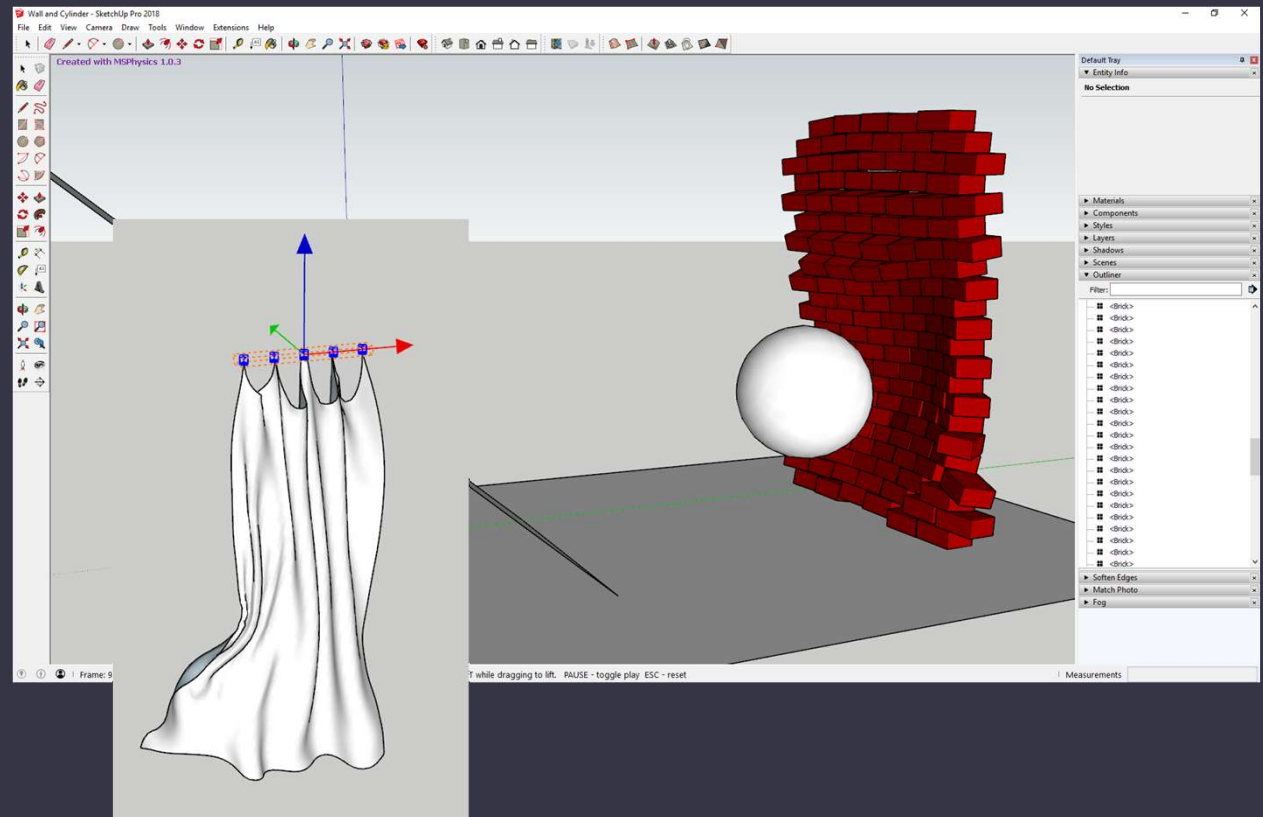





# Extension Workshop



# Sandbox Tools

Site and Face Editing Tools

- Built-In to SketchUp
- Suite of tools for doing sitework in SketchUp
- “Window,” “Extension Manager,” “Enable Sandbox Tools”

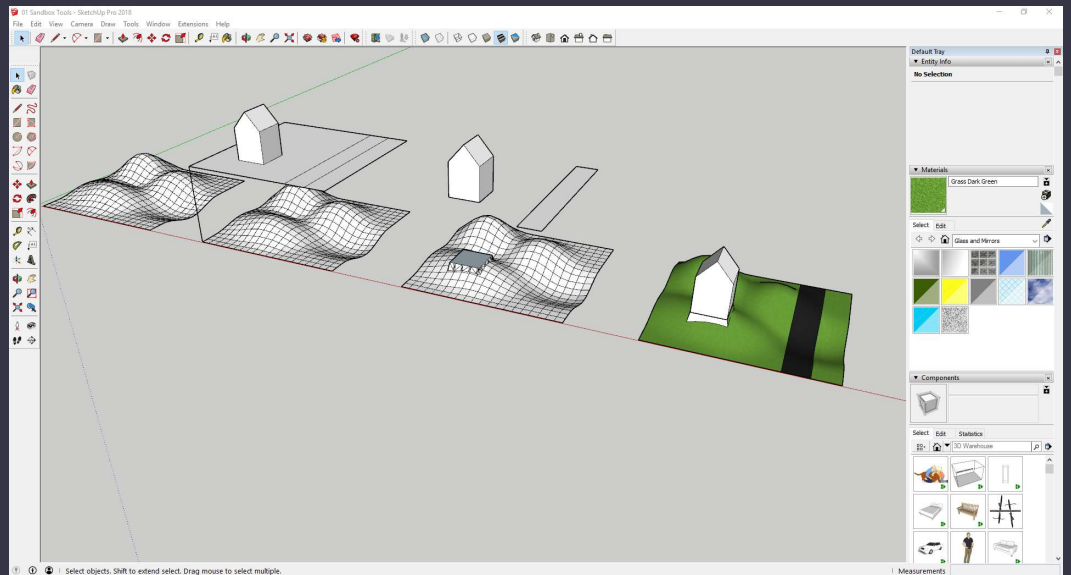

# Selection Toys

Powerful Selection Tool

- Developer: Thom Thom
- Cost: Free
- Location: SketchUp Extension Warehouse
- Install “tt\_selection\_toys-2.4.0”

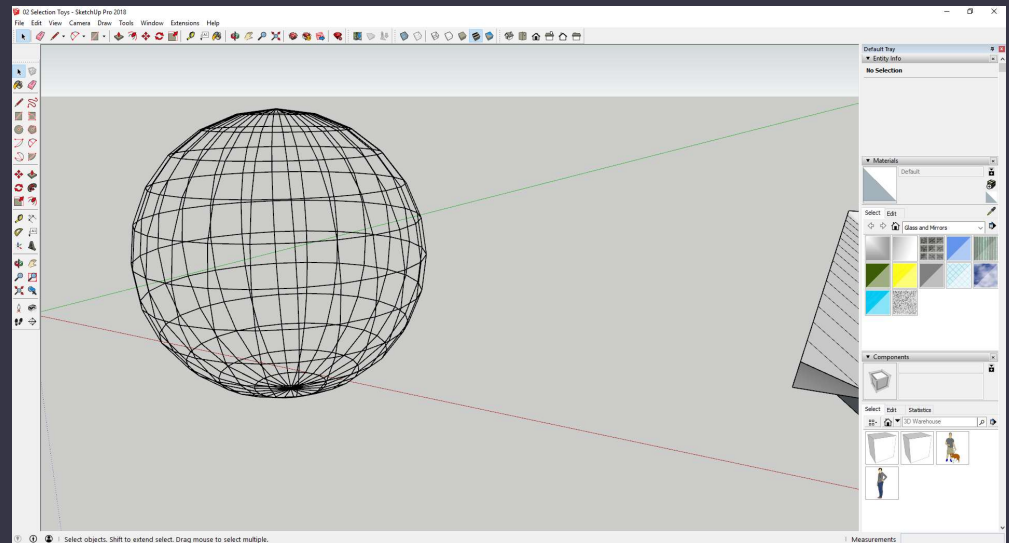

# RoundCorner

## Round and Bevel Edges

- Developer: Fredo6
- Cost: Free
- Location: SketchUcation Extension Warehouse
- FIRST install  
“LibFredo6\_v8.5h”
- THEN install  
“RoundCorner\_v3.2g”

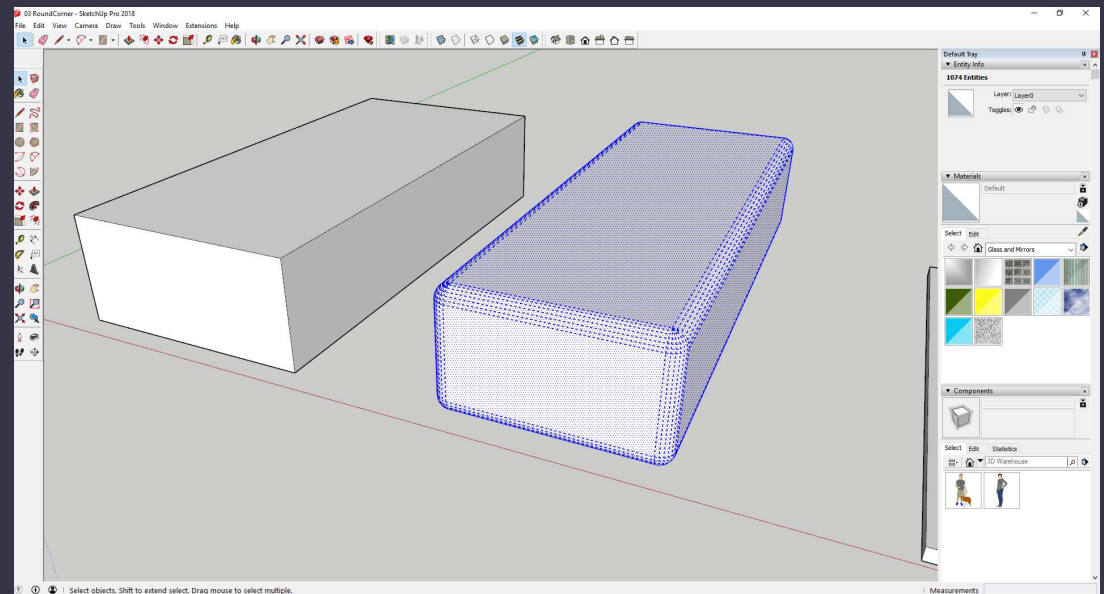

# ThruPaint

## Material and UV Mapping

- Developer: Fredo6
- Cost: Free
- Location: SketchUcation Extension Warehouse
- Contained inside another extension – install “FredoTools\_v3.2d”

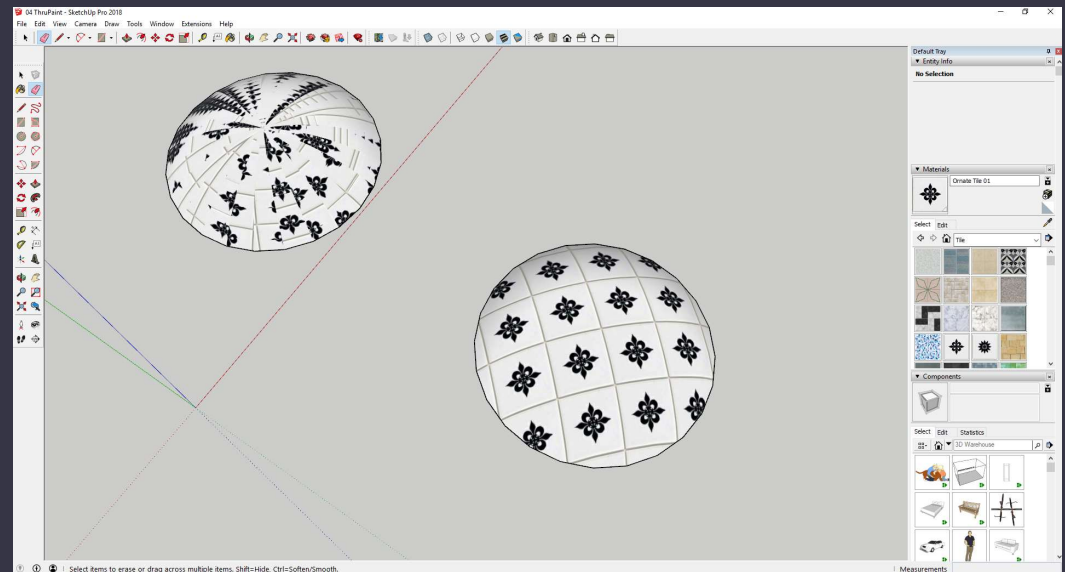

# Joint Push Pull

Push/Pull Curved Faces, Multiple Faces at Once

- Developer: Fredo6
- Cost: Free
- Location: SketchUcation Extension Warehouse
- Install “JointPushPull\_v4.3f”

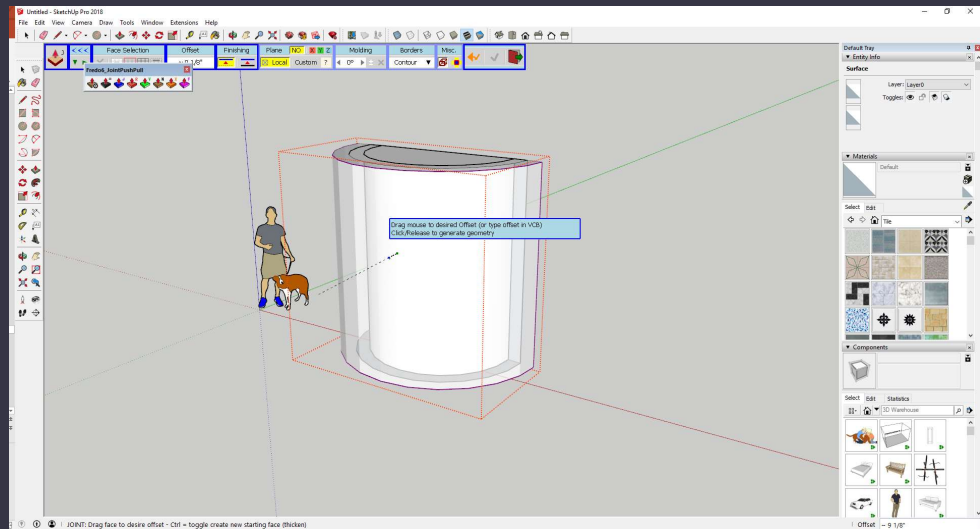

# Slicer

Cut Manifold Solids into Slices

- Developer: TIG
- Cost: Free
- Location: SketchUcation Extension Warehouse
- Install “TIG\_Slicer\_v5.23”

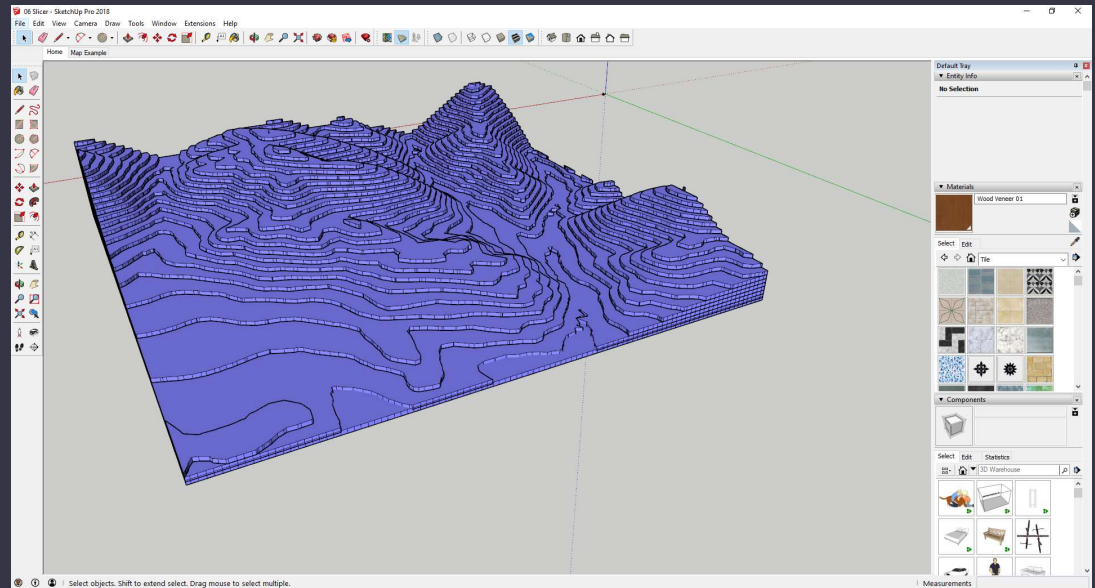

# Curviloft

Loft Shapes and Create Skins

- Developer: Fredo6
- Cost: Free
- Location: SketchUcation  
Extension Warehouse
- Install “Curviloft\_v1.7d”

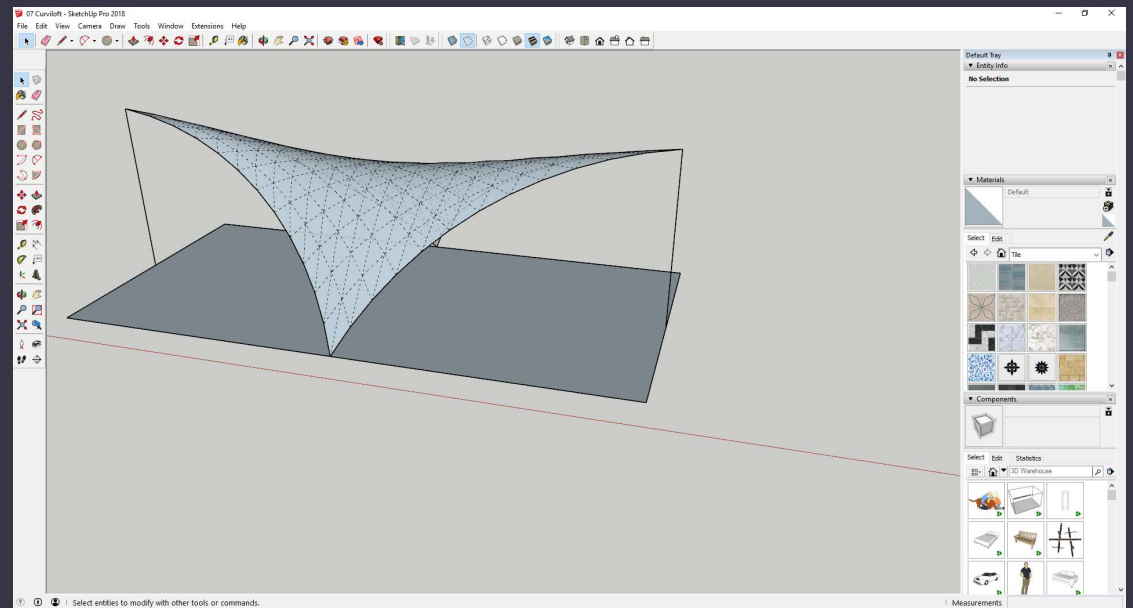



# Flowify

Bend Objects along complex shapes

- Developer: Fredo6
- Cost: Free
- Location: SketchUcation Extension Warehouse
- Install “flowify\_v1.1.0”

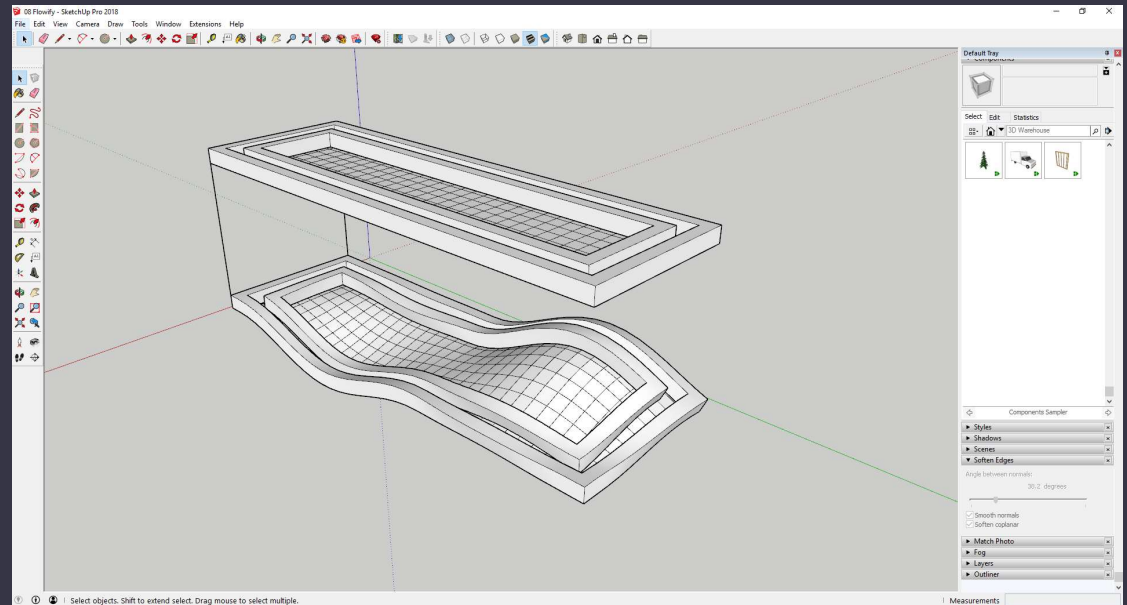

# Animator

Create moving animations in SketchUp

- Developer: Fredo6
- Cost: Free
- Location: SketchUcation  
Extension Warehouse
- Install "Animator\_v2.2.c"

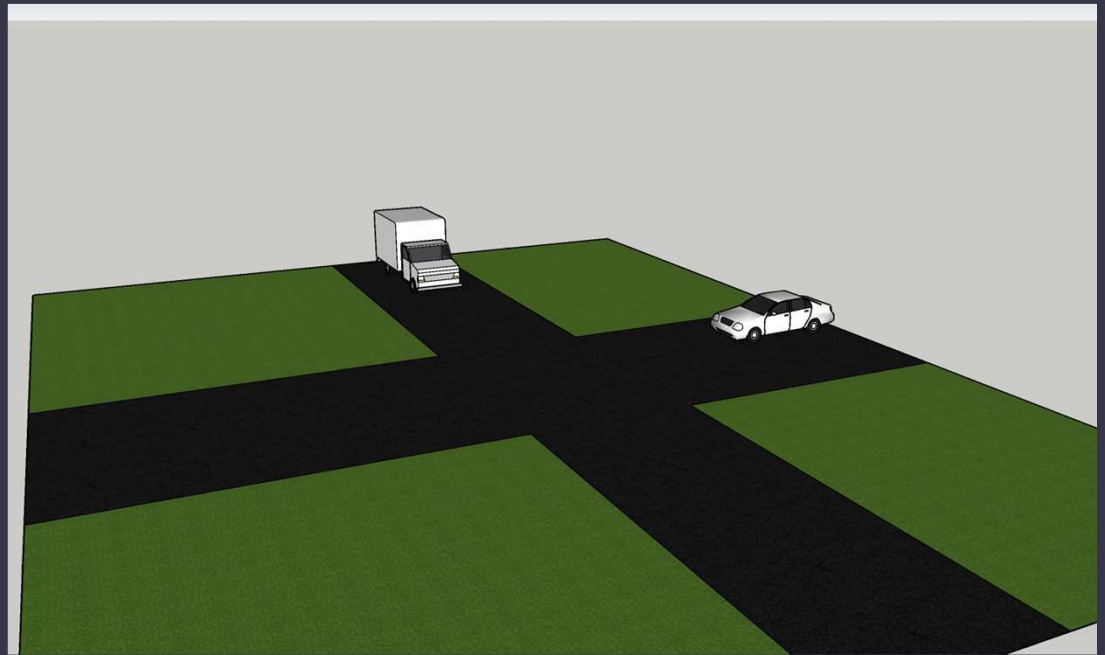

Tutorials and Links for all these extensions at  
**[www.thesketchupessentials.com/Basecamp2018](http://www.thesketchupessentials.com/Basecamp2018)**

---

[Justin@thesketchupessentials.com](mailto:Justin@thesketchupessentials.com)

[YouTube.com/TheSketchUpEssentials](https://www.youtube.com/TheSketchUpEssentials)

